SOLID 90 A3
SOLID 105 A3
SOLID 120 A3

Operator's Manual

Edition 1.1M



Table of Contents

Chapter	Page
1. Introduction	7
1.1. General Description	7
1.2. Conventions	10
1.3. CE - Conformity	11
1.4. General Safety Instructions	12
2. Installation	14
2.1. Check List	14
2.2. Environment and Power Standards	15
2.3. Device Components	18
3. Paper Handling	19
3.1. Useable Print Media	19
3.2. Print Media Handling (Paper, e.g.)	20
3.2.1. Loading Paper into Tray 1 and 2 (without changing the paper size)	21
3.2.2. Changing the Paper Size of Tray 1 and 2	24
3.2.3. Loading Paper into Tray 3 and 4 (without changing the paper size)	28
3.2.4. Changing the Paper Size of Tray 3 and 4	31
3.2.5. Loading Paper in the Bypass Tray (Option)	33
4. Operation and Menu Structure	39
4.1. Attaching the Printer to a Network/PC and to the Power Supply	39
4.2. Print System Power On	41
4.3. Operation Panel of the Device	44
4.4. WebPanel User Interface	45
4.4.1. Using the Touchscreen	45
4.4.2. Information Page	46
4.4.3. Configuration Page	47
4.4.4. Menu Page for Page Configurations	48
4.4.5. Network Page	49
4.4.6. Interfaces Page	51
4.4.7. EEPROM Page	52
4.4.8. User Page	54

4 Table of Contents

Chapter	Page	
4.5.	IP-Panel User Interface	55
4.6.	Remote-Controlling the SOLID 90 A3	57
4.6.1.	Abstract	57
4.6.2.	Details of the IP-Panel Elements	59
4.7.	Configuration via the Control Panel	61
4.8.	Menu Structure	62
4.9.	Syntax of Diagrams	67

5. Panel Functions **68**

5.1.	Printing the Status Sheet	68
5.2.	Printing the Font List	70
5.3.	Choosing Print Resolution	71
5.4.	Hexdump Mode Activation	73
5.5.	Normal Print Mode Activation (incl. FORM FEED)	74
5.6.	Clearing the Input Buffer (Cancel Job)	75
5.7.	Printing the Menu Page	76
5.8.	Generating Testsheets (Sliding Pattern)	77
5.9.	Feeder Selection (Tray)	78
5.10.	Stacker Selection	80
5.11.	Output Face Selection (Face Up or Face Down)	82
5.12.	Print Mode Selection (Simplex/Duplex)	83
5.13.	Paper Size Selection	85
5.14.	Print Direction Selection	86
5.15.	Data Interface Configuration	87
5.16.	Emulation Selection	88
5.17.	Display Language Selection	90
5.18.	Transparent Code Adjustment	91
5.19.	Selection of Memory Distribution (Input Buffer)	92
5.20.	Setting to Factory Default	93
5.21.	Font Selection	94
5.22.	Text Orientation Selection	97
5.23.	Symbol Code Selection	98
5.24.	Configuration of Text Margins	99
5.25.	Lines per Inch Setting (Line Spacing)	101
5.26.	Number of Characters per Inch Setting (Character Spacing)	102
5.27.	Configuration of Network Parameters (IP Address, e.g.)	103

Chapter	Page
6. Operator Maintenance	107
6.1. Printer Cleaning	107
6.1.1. Printer Cabinet Cleaning	107
6.1.2. Cleaning the Printer Interior	108
6.2. Replacing the Toner Cartridge	109
6.3. Replacing the Waste Toner Bottle (Toner Collection Container)	116
7. Troubleshooting	119
7.1. Error in the Print Process	120
7.2. Reduced Print Quality	121
7.3. Error Messages	122
7.3.1. Consumables missing	123
7.4. Print Media Jam	124
7.4.1. Avoiding Jams	124
7.4.2. Clearing Jams from the Printer	126
7.4.3. Clearing Jams in the Conveyor Unit	127
7.4.4. Clearing Jams in the Transport Area	140
7.5. Solving Paper Feed Problems	142
7.6. Print Repeat after an Error	144
8. Measures for Transport and Shipping (Repacking)	145
9. Specifications	147
10. Index	151

1. Introduction

1.1. General Description

The print systems SOLID 90 A3, SOLID 105 A3 and SOLID 120 A3 work on an electrophotographical base employing a laser as exposure unit. A print resolution of 300 dots per inch (dpi) or 600 dpi can be chosen. 600 dpi is corresponding to about 24 pixels per mm.

The maximum print speed of the SOLID 120 A3 is 120 pages per minute (Letter or A4). For the size of A3 the maximum print speed of this print system is 54 pages per minute.

The SOLID 90 A3, the SOLID 105 A3 and the SOLID 120 A3 are able to process different paper qualities with a weight from 60 to 220 g/m² (up to 300 g/m² ; options are required). Paper sizes from A5R to A3W are fed from adjustable cassettes.

These print systems offer a lot of options to enlarge the abilities in case of paper input, paper output and finishing. So these print systems are best prepared for the integration into production lines.

All three print systems (SOLID 90 A3, SOLID 105 A3 and SOLID 120 A3) ship - as a standard - with one 1,200 sheet cassette, one 800 sheet cassette (both A4/Letter) and two adjustable 500 sheets cassettes (A5R to A3W and B5R to A3W).

A multitude of options are available:

- a manual feeder for the main device (printer) containing up to 100 sheets of plain paper
- a large capacity tray for up to 5,000-sheets (in two trays)
- a manual feeder for large capacity trays containing up to 500 sheets of plain paper
- a finisher (A5R to A3W)

This listing of options isn't complete – please ask your supplier for more information. All options promote the excellent paperhandling functionality of the print systems SOLID 90 A3, SOLID 105 A3 and SOLID 120 A3.

The printer's touchscreen is used (for all three print systems in the same way) to display the windows to perform a variety of device operations:

The WebPanel is a new way to present the configuration opportunities of the printer as a „page-oriented“ application.

You also have the choice to use the so called IP-Panel. IP-Panel presents a virtual control panel of the printer, as you know it from other MICROPLEX printers.

Both variants of user interfaces are provided for remote controlling of the three print systems, too.

The presentation on the printer's touchscreen is comparable to the presentation via web browser during remote controlling.

You can use both, the MICROPLEX WebPanel and the IP-Panel to change the configuration of the print system and customize your printer to meet your specific needs.

The capabilities featured include the MICROPLEX page description language IDOL. Using this language, complex tasks such as the creation of forms can be carried out by simple software commands (see separate IDOL manual).

Consequently there is a multitude of scopes for the print systems SOLID 90 A3, SOLID 105 A3 and SOLID 120 A3. It is suitable for high-speed printing with excellent print quality using different types of materials.

Fundamentals of Digital Printing

Digital information (like a form with text, a company logo and vector graphics) is transferred from the EDP - system to the laserprinter's input buffer in a coded manner called an "emulation" or "page description language".

The controller decodes information and defines letters, numbers, graphics, etc. into bit patterns and posts them into the controller's frame store. This way, a copy of the future print which is generated by dots is produced.

The electronically controlled laserbeam now plots the dot pattern in rows onto the light-sensitive surface of a rotating precharged drum. Toner is caused to adhere to the electrostatic latent image formed on the drum surface. This image consisting of toner particles is electrically transferred onto the paper, which is guided past the drum. This process is supported by an electrostatic field below the paper (transfer charger).

When transported further, the toner particles, which are affected by heat and pressure, are combined resistantly with the paper inside the fusing unit. The drum is discharged and cleaned.

1.2. Conventions

To find the requested information more quickly and to understand instructions more easily, the following symbols are used:



This symbol refers to a possible source of danger. If you do not pay attention to this information, injuries may result, the functioning of the printer could be reduced, or the device could be damaged.



This symbol refers to important hints and suggestions on using the printer. Disregarding these hints might cause problems with the printer or within the environments.



This symbol represents a key of the touchscreen or the IP-Panel. Such symbols will be used in this manual whenever control panel buttons must be pushed in order to activate certain functions.

[blue colored text](#)

Link to another chapter or a different document. By clicking the blue colored text you'll enter the concerning chapter or document.

[Menu Level 1]

This symbol represents messages shown in the display.

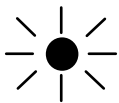

This symbol shows a shining LED (light emitting diode). The SOLID printer panel is provided with one LED.

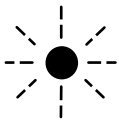

This symbol shows a flashing LED.



This symbol will be used in this manual to show an LED that is not shining.

1.3. CE - Conformity



EC DECLARATION OF CONFORMITY

Manufacturer: **MICROPLEX Printware AG**
Panzerstrasse 5
D-26316 Varel
Germany

Product: Laser Printer

Type: SOLID 90 A3
SOLID 105 A3
SOLID 120 A3

Conforms with the following EC directives:

EN 60950-1	(Low voltage directive)
EN 55022/Class A	(Information technology equipment – Radio disturbance characteristics – Limits and methods of measurement)
EN 55024, EN 61000-6-2	(Immunity for industrial environments)
EN 61000-3-2	(Limitation of voltage changes, voltage fluctuations and flicker in public low-voltage supply systems)
EN 61000-3-3	

Varel, 14.5.2014

Managing Director
Jürgen Schmitt

On the basis of this declaration, this product will bear the following mark:



1.4. General Safety Instructions



This device produces, employs and possibly radiates high frequency energy. Because of this, incorrect installation can disturb radio communications.

Laser Notice

This printer is certified as a Class 1 laser product (DHHS Department of Health and Human Services). The laser system and printer are designed so there is never any human access to laser radiation above a Class 1 level during normal operation, user maintenance, or prescribed service condition.



All handling or procedures that differ from the ones being described in this manual are to be omitted. Disregarding might release dangerous laser radiation.

This MICROPLEX product and its consumables are designed and tested according to strict safety standards.

By heeding the following instructions, the user is ensured safe operations:



- Please make sure your electricity source is properly grounded.
- Install the device on solid and level ground.
- Only trained staff are authorized to transport the equipment, because careful attention to the characteristics of the devices is necessary.
- Only use consumables which are specially developed for this device.



- Using improper consumables may cause a reduction of output quality or damage to the device.
- Ensure no liquids get on or into the device.
- Do not remove any cover or safety device fastened by screws.
- Do not bridge a safety device.
- Do not push anything into the ventilation apertures.



- Never carry out installations, cleanings, or maintenance operations which are not described in this manual. These operations should only be done by MICROPLEX authorized service personnel.



In order to disconnect the printer quickly from the main power in the event of an emergency, please note the following:

- The device is possibly equipped with 2 power cords, both have to be disconnected for power-off!
- For devices connected by plugs, the power-outlets should be installed near the device and easily within reach.
- For permanently connected devices, an easily accessible emergency power-off switch should be installed close to the device.
- Please do not conceal the disconnect devices with the printer or other objects.



- Please follow all the instructions and hints directly attached to the device and/or described in this manual.
- To ensure optimum printer performance, only use MICROPLEX consumables.

2. Installation

2.1. Check List

First, place the printer and the accessories onto a level surface until the final location of the printer is chosen.

Please make sure that there are no transport damages and that everything is included.

Damages should be reported to the supplier immediately.

Carefully open the boxes to make sure the following contents are included:

1. Printer (basic unit, for example SOLID 90 A3)
2. additional (optional) components, if ordered
3. CD containing:
 - Operator's Manual SOLID 90 A3 /105 A3 / 120 A3
 - Print drivers
 - IDOL Manual



The printer's first installation has to be done by a trained service engineer.

Please retain the original packing materials in case the printer has to be transported in the future (see chapter 8 Measures for Transport and Shipping (Repacking)).

2.2. Environment and Power Standards

- Required space:

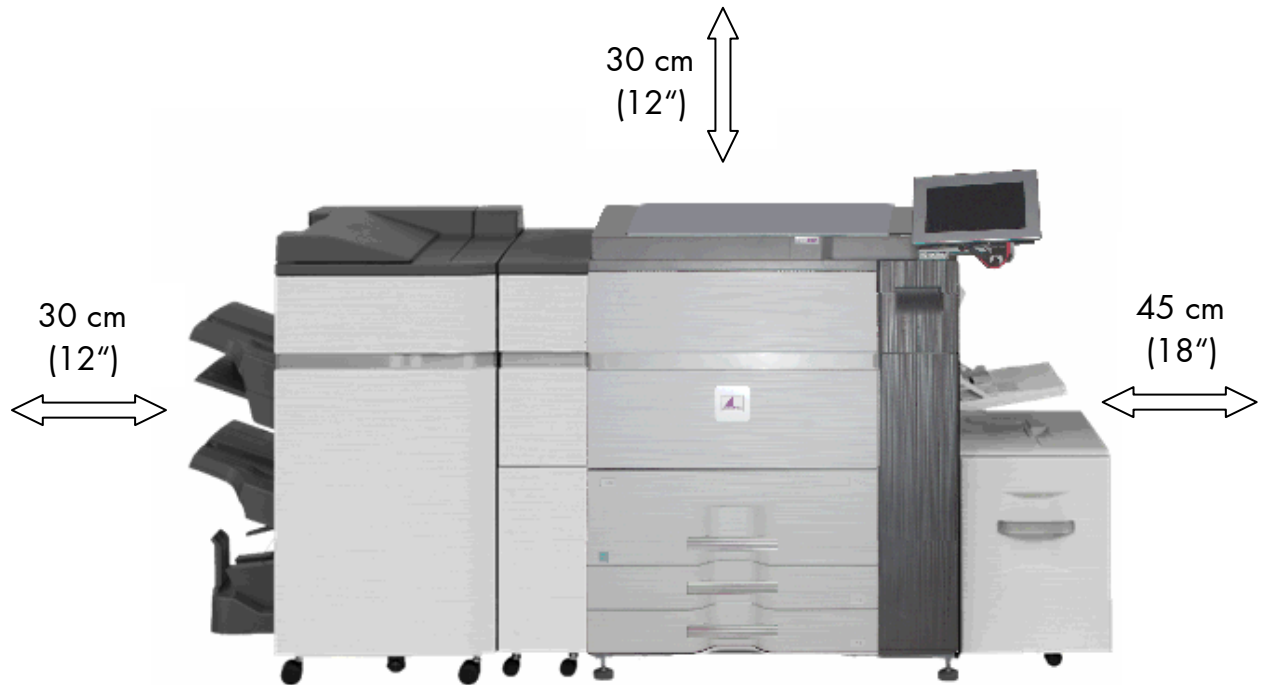

Fig. 2.2.a Required space for the print system (the dimensions are valid for SOLID 90 A3, 105 A3 and 120 A3 – in each case with several options)



The printer's first installation has to be done by a trained service engineer.

- The chosen location should be clean, dry and well-ventilated.
- Damaging environmental factors such as metal vapors, oil mist, corrosive leaches or the like must not affect the printer.



- Place the print system on a horizontal, firm and solid surface.
- The print system environment has to be free of shocks or vibrations.



- The print system and sockets have to be easily accessible.
- The print system should not be located near volatile or combustible materials (e.g. a curtain).



- To avoid damage to your SOLID print system, the devices must be switched off (e.g. cut off from the power supply) before the user begins connecting the interface lines.



- The components of the print system must be connected to appropriate AC power sources 208 - 240V AC /60 Hz (North America) or 220 – 240V AC /50 Hz (Europe, United Kingdom e.g.).
The power sources must be properly grounded. The sockets and power cords must not be damaged.

- Use the print system only within the allowed fluctuation range of $\pm 10\%$.
- The power source must be free of noise, and not subjected to surges or noise (e.g. generated by big machines).



If you're going to move or transport the printer, keep the following in mind:

- Installation and deinstallation of the print system should be done by a trained service engineer.
- The print system is heavy (approximately 300 kg; additional options will increase this value).
- Be sure to plug the printer into properly grounded outlets in the new location.

- Please note the following environment conditions are needed to operate the printer at full capacity:

Temperature: +10°C (50°F) to +30°C (86°F)
(up to +35°C (95°F) while max. 60%)

Relative atmospheric humidity: 20% to 85%



- Do not expose the print system to abrupt temperature changes (heating, window or air conditioning).
- The print system should not be exposed to direct sunlight.

2.3. Device Components

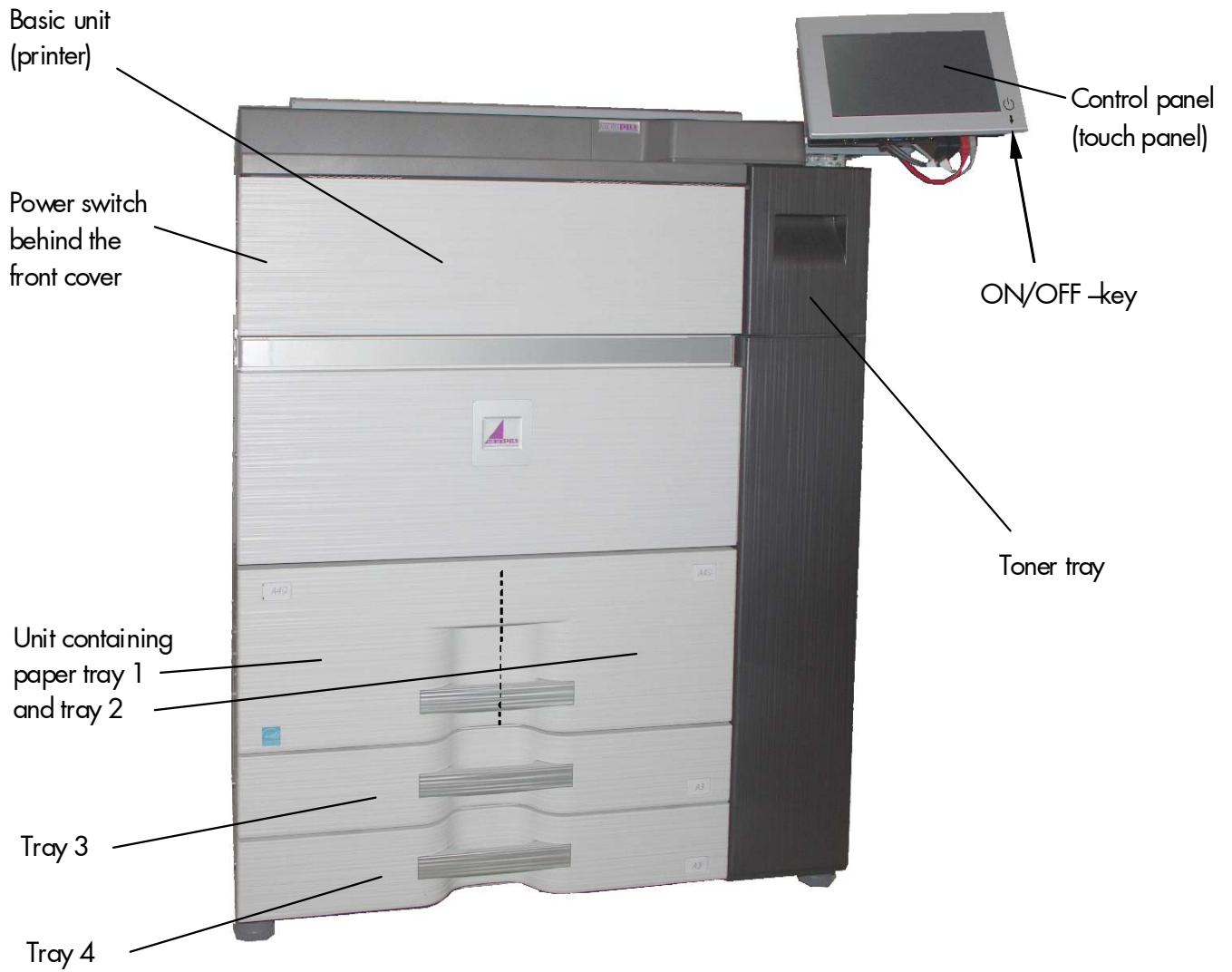

Fig. 2.3.a Print System (for example SOLID 90 A3; here without options)

3. Paper Handling

3.1. Useable Print Media



Only use consumables that are approved.
Using unsuitable consumables may cause a reduction of output quality or damages.

The following table illustrates various paper types and the printer's ability to process them by the different paper trays.

	Tray 1/Tray 2	Tray 3	Tray 4	Manual Feeder (option)
Plain paper (60g/m ² up to 105g/m ² (16 lbs up to 28 lbs))	Yes	Yes	Yes	Yes
Recycled paper	Yes	Yes	Yes	Yes
Coloured	Yes	Yes	Yes	Yes
Preprinted	Yes	Yes	Yes	Yes
Letter head	Yes	Yes	Yes	Yes
Prepunched	Yes	Yes	Yes	Yes
Heavy paper 1 (106 up to 176 g/m ² (28 lbs bond up to 65 lbs Index))	NO	Yes	Yes	Yes
Heavy paper 2 (177 up to 220 g/m ² (65 lbs Index up to 80 lbs Cover))	NO	Yes	Yes	Yes
Heavy paper 3 (221 up to 256 g/m ² (80 lbs bond up to 140 lbs Index))	NO	NO	NO	Yes
Heavy paper 4 (257 up to 300 g/m ² (140 lbs Index up to 100 lbs Cover))	NO	NO	NO	Yes
Labels	NO	NO	Yes	Yes
Transparency film	NO	NO	Yes	Yes
Tab paper	NO	NO	Yes	Yes
Thin paper	NO	NO	NO	Yes

Note: All print media as, for example, recycled paper, colored paper and so on must meet the same specifications as plain paper. Contact your dealer or service staff for advice on using these types of paper.

Load the paper with the **print side face down**.

3.2. Print Media Handling (Paper, e.g.)



The printer processes the sizes A5R up to A3W (see Specifications and table in section 3.1) with paper weights from 60 to 220 g/m².



Paper jams can be avoided by accurately and carefully filling the paper cassettes.



Please do not open or remove a paper cassette while the printer is running. This may cause a paper jam.

Please notice the specifications about the paper's "print-side" (see the information on the paper packing).

If, for example, the empty paper tray 1 has to be refilled (without changing the paper size, compare section 3.2.2), do the following:

3.2.1. Loading Paper into Tray 1 and 2 (without changing the paper size)

The print systems SOLID 90 A3, SOLID 105 A3 and SOLID 120 A3 have four standard paper trays. Two of them (tray 1 and 2) are contained in a unit (see Fig. 3.2.1.a).

Tray 1 can hold up to 1200 sheets of A4 size (or: 1200 sheets of letter size 8.5"x 11"). Tray 2 can hold up to 800 sheets of A4 or letter.

1. Gently pull the unit (tray 1 and 2) out until it stops.

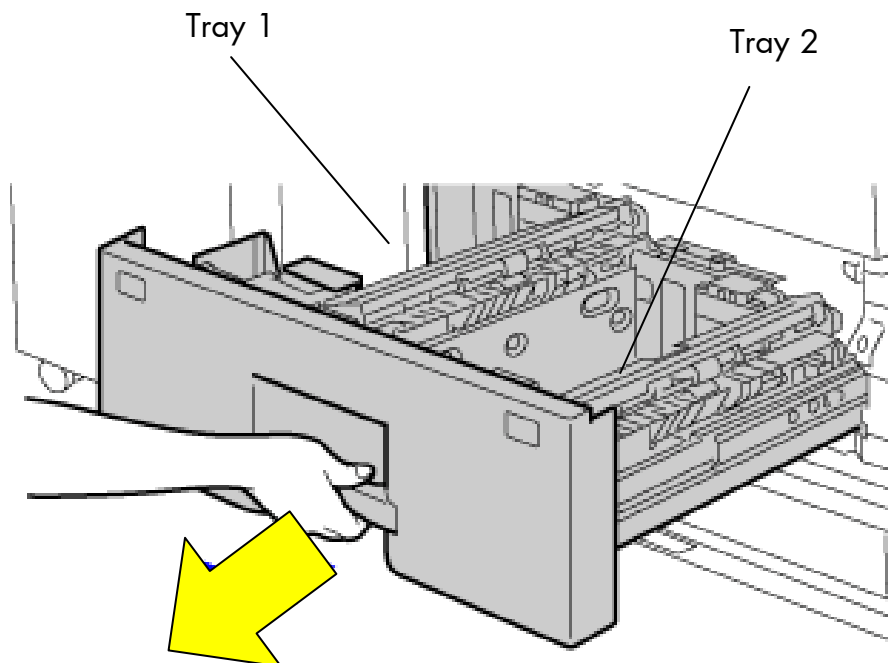

Fig. 3.2.1.a Pulling out the unit (paper tray 1 and 2)



Do not place heavy objects on the trays or press down on the unit.



Fan the paper well before loading it.
If the paper is not fanned, multiple sheets may feed at once and cause a misfeed.

2. Flex the sheets back and forth to loosen them, and then fan them. If the paper is not fanned well, multiple sheets may cause a misfeed. Do not fold or crease the print media.

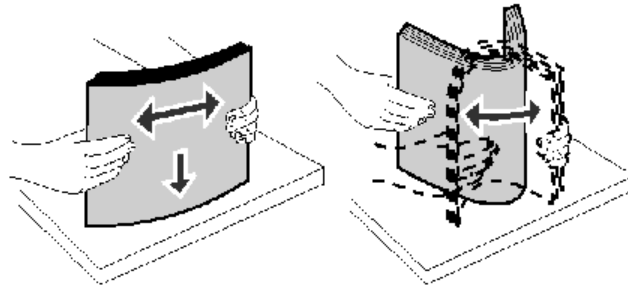

Fig. 3.2.1.b Fanning and aligning the paper pile

3. Straighten the edges of the stack on a level surface.
4. Raise the feed roller of **Tray 1** (left tray). See the little yellow arrow in the following figure.
5. Load the print media (paper) with the print side face down into the left tray.

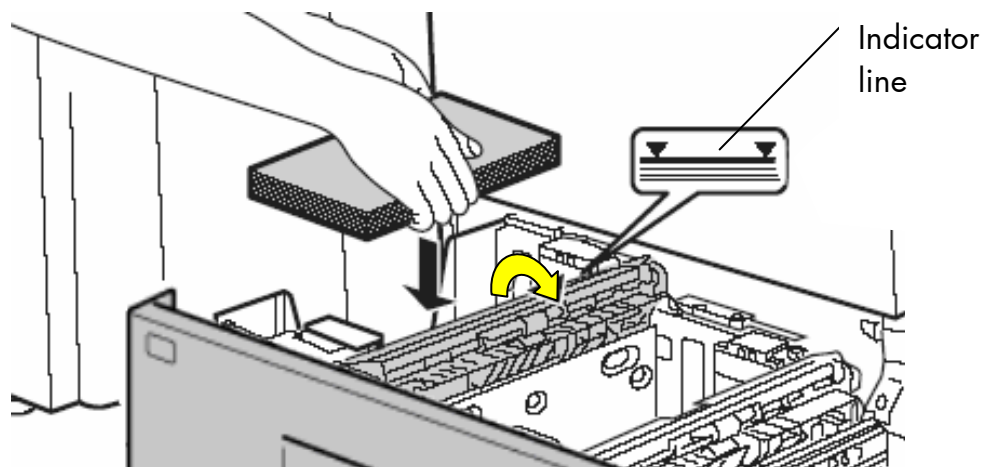

Fig. 3.2.1.c Raising the feed roller and loading print media into tray 1



The stack must not exceed the maximum stack height indicated by the indicator line.

6. Let the feed roller of the left tray turn back into its origin position after paper loading.

7. Flap the feed roller of **Tray 2** (right tray) to the right (see the small arrow in the following figure).
8. Load the print media (paper) with the print side face down into the right tray.

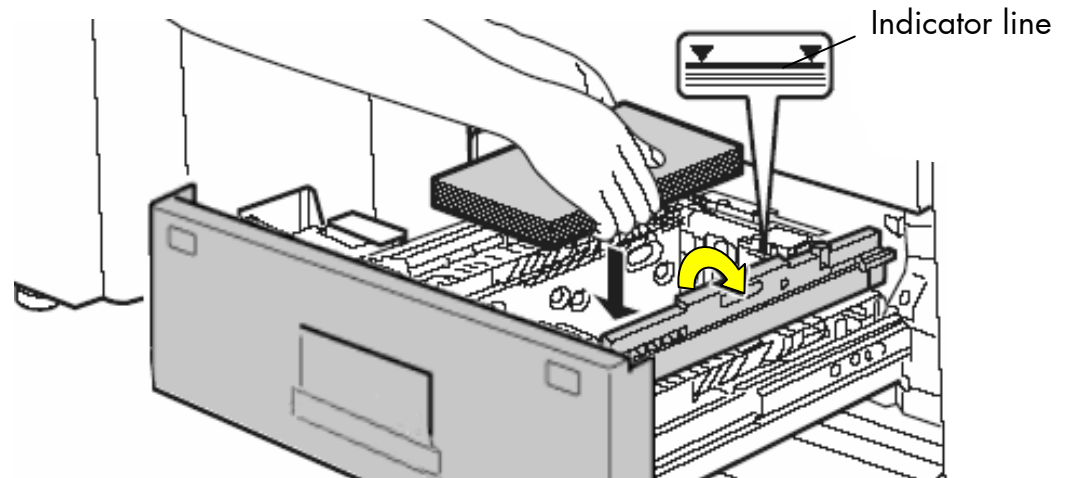

Fig. 3.2.1.d Raising the feed roller and loading print media into tray 2



The stack must not be higher than the indicator line.
Do not load bent or wrinkled print media.

9. Please turn the feed roller of the right tray back to its original position after loading the paper.
10. Gently slide the unit all the way into the device.

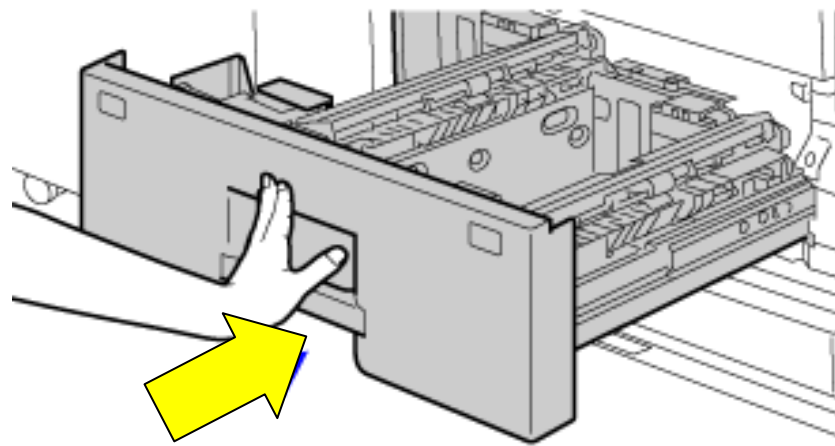

Fig. 3.2.1.e Sliding the unit (tray 1 and 2) into the device

3.2.2. Changing the Paper Size of Tray 1 and 2

Removing the paper size guide

1. Remove any existing paper from the tray.



When removing and attaching the paper size guides, take care not to hit the front cover of the device.

2. To remove the first paper size guide of **tray 1**, follow the steps below:
3. Press the base of the tray 1 all the way down and hold it down.
4. Press the „hook“ (centrally „leg“) of the paper size guide to the right in order to unlock it.
Slightly pull the paper size guide up to remove it from the openings in the base of the paper tray.

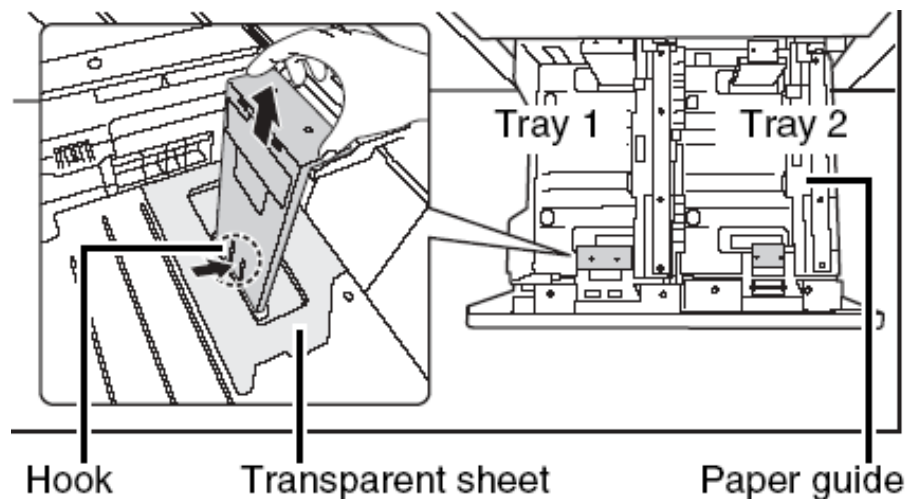

Fig. 3.2.2.a Removing the paper size guide

5. Before changing the paper size of **tray 2**, flap the paper guide to the right. (Compare figure above and the small arrow in Fig. 3.2.1.d). Thereafter remove the first paper size guide of this tray as described in step 3 and 4.

Attaching the paper size guide and the transparent sheet

The reinstallation of the paper size guide (according to the new paper size) is identical for tray 1 and 2:

6. Align the bottom of the paper size guide with the appropriate slot for the paper size to be used (indicated by the paper size mark on the base of the tray).

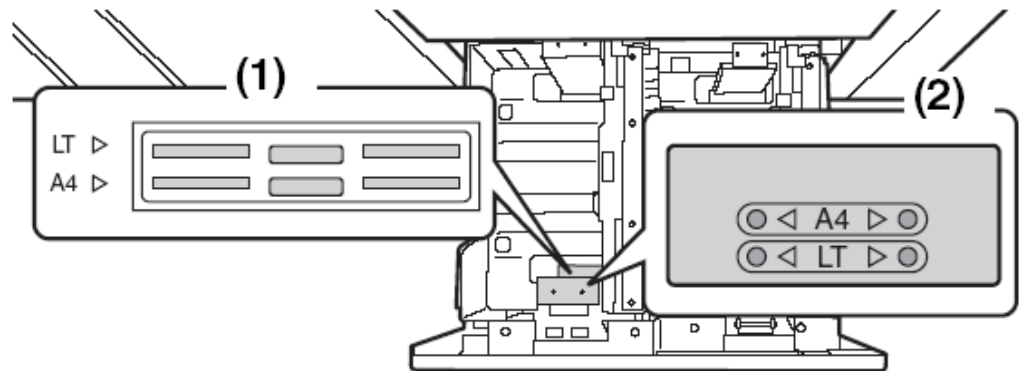

Fig. 3.2.2.b Paper size marks in tray 1

7. Align the holes at the top of the paper size guide with the protrusions that secure the paper size guide. (Please pay attention to the paper size mark as well).



Make sure that the top and bottom of the paper size guide are aligned to the same paper size.

If the top and bottom of the guide are not aligned to the same paper size, skewed feeding and misfeeds will result!

8. Push the paper size guide (or rather its 3 „legs“) into the openings at the bottom of the tray until the hook at the bottom locks into place. (You will hear a "click" when the hook locks.)

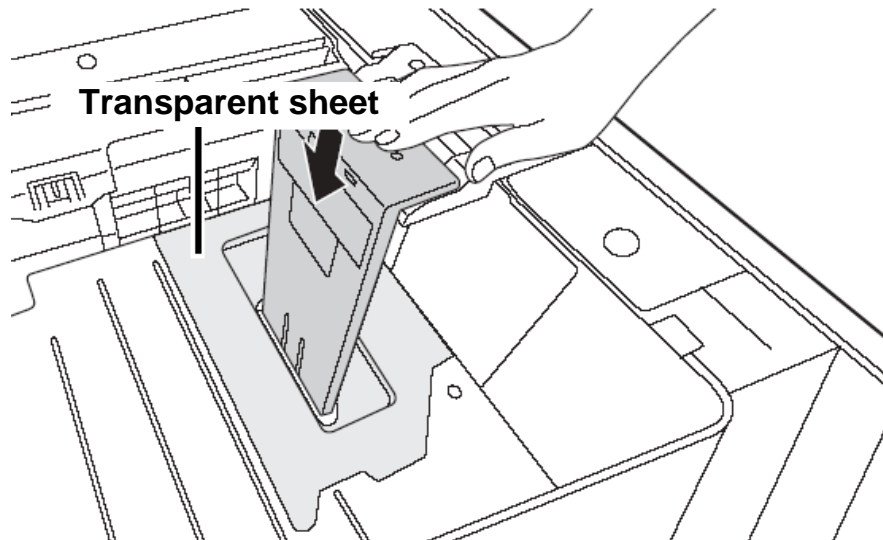

Fig. 3.2.2.c Locking the paper size guide



When attaching the paper size guide, place the transparent sheet in direct contact with the base of the tray in the correct orientation as shown in figure 3.2.2.c.

9. Repeat the steps above to **adjust** the **second (far) paper size guide** of the tray (1 or 2) **as well**. Both paper size guides have to be adjusted according to the new paper size.

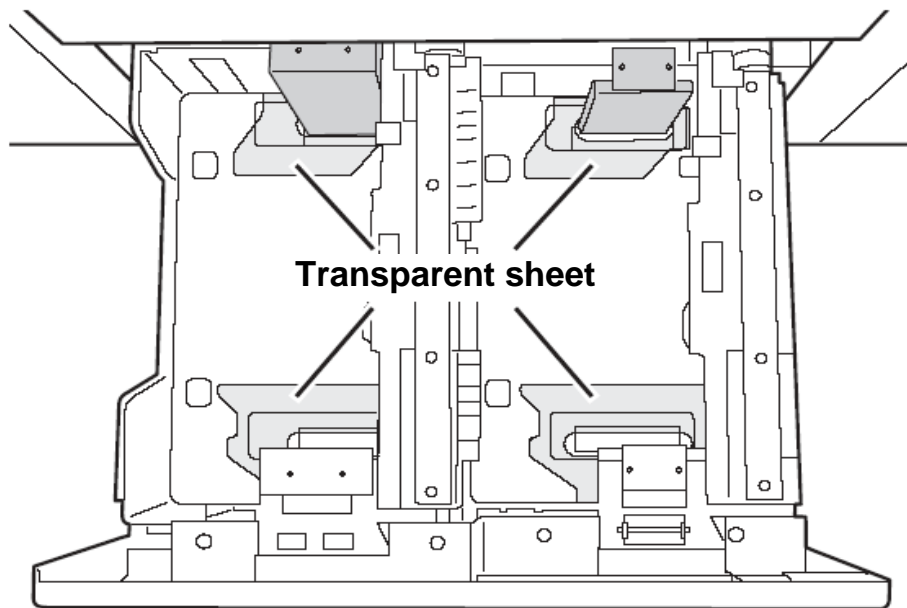

Fig. 3.2.2.d Adjust both paper size guides of the tray
(Each tray (1 and 2) is equipped with 2 guides)



Be sure to adjust the far paper guide to the same size as the first (near) paper guide.

If the two guides are not aligned to the same paper size, skewed feeding and misfeeds will result!

10. Load the print media stack (paper) with the print side face down into the right tray.

Refer to section 3.2.1 Loading Paper into Tray 1 and 2 for more details.

Updating the System Settings



Always take care that the settings of the device match the paper that you loaded.

If, for example, the **paper type** setting is not configured correctly, automatic paper selection will not operate correctly. Printing may take place on the wrong size or type of paper or a misfeed may occur.

11. Update the system settings via the touch panel of the printer.

3.2.3. Loading Paper into Tray 3 and 4 (without changing the paper size)

Up to 500 sheets of B5R to A3W size paper (7-1/4" x 10-1/2"R up to 11" x 17" size) can be loaded in tray tray 3.

Up to 500 sheets of A5R to A3W size paper (5-1/2" x 8-1/2"R up to 11" x 17" size) can be loaded in tray tray 4.

Refer to section 3.1 for more details about useable print media.

1. Gently pull the tray (tray 3 or 4) out until it stops.

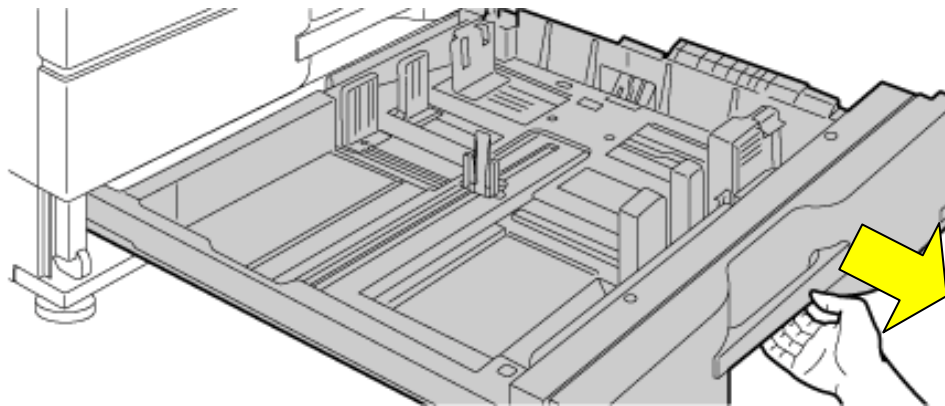

Fig. 3.2.3.a Pulling out the tray



Do not place heavy objects on the trays or press down on the unit.



Fan the paper well before loading it.

If the paper is not fanned, multiple sheets may feed at once and cause a misfeed.

2. Flex the sheets back and forth to loosen them, and then fan them.
If the paper is not fanned well, multiple sheets may cause a misfeed. Do not fold or crease the print media.

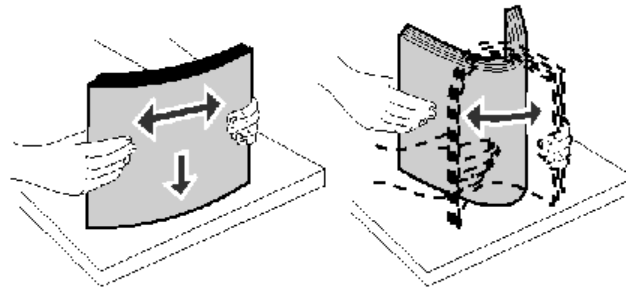

Fig. 3.2.3.b Fanning and aligning the paper pile

3. Straighten the edges of the stack on a level surface.
4. Load the print media (paper) with the print side face down into the tray.

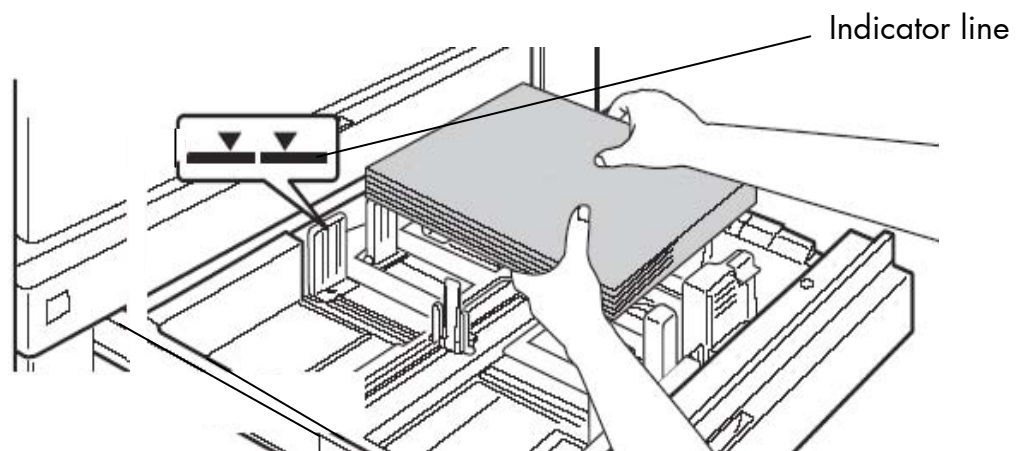

Fig. 3.2.3.c Loading print media into the tray (tray 3 or tray 4)



Do not load bent or wrinkled print media.



Note: The stack must not exceed the maximum stack height indicated by the indicator line.

5. Gently slide the tray all the way into the device.

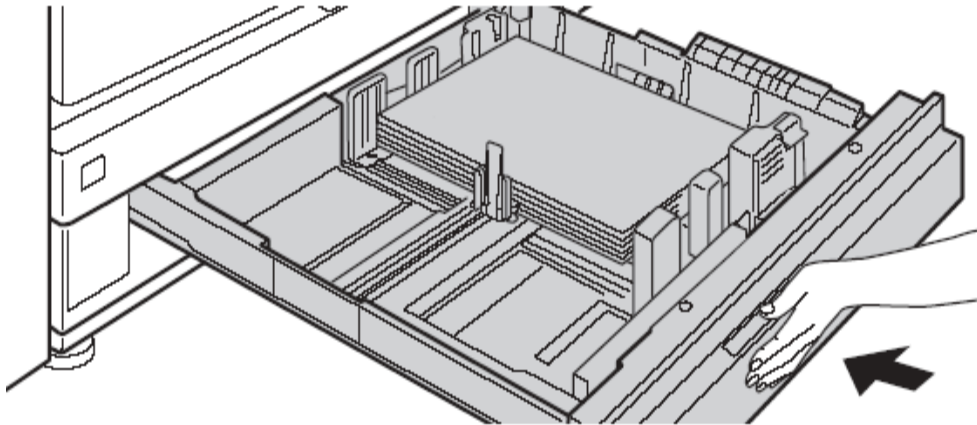

Fig. 3.2.3.d Sliding the tray (tray 3 or tray 4) into the device

3.2.4. Changing the Paper Size of Tray 3 and 4

1. Remove any existing paper from the tray.
2. Unlock the guide plate B by pressing its pressure sensitive area and slide the guide plate to the desired paper size.

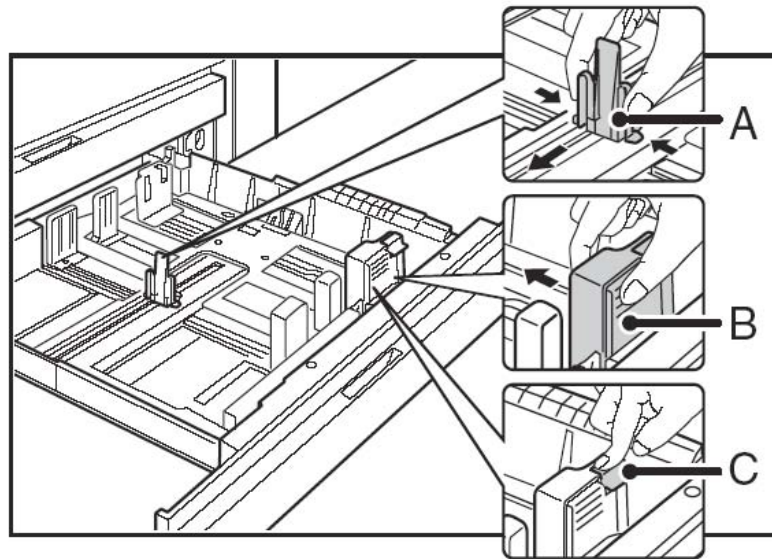

Fig. 3.2.4.a Unlocking the paper guides



If the guide plate B is slid to a standard paper size, it will lock automatically.

3. If the guide plate B is set to a non-standard paper size, after sliding the guide plate B to the desired size, the lock button C (see figure above) has to be pressed.



Non-standard paper sizes can only be loaded in tray tray 4 (not in tray 3).

4. Squeeze the two lock levers of the paper size guide A (as shown in figure 3.2.4.a) and slide the paper guide to the desired paper size.
5. Load the print media stack (paper) with the print side face down into the right tray.
Refer to section 3.2.3 Loading Paper into Tray 3 and 4 for more details.

Updating the System Settings



Always take care that the settings of the device match the paper that you loaded.

If, for example, the **paper type** setting is not configured correctly, automatic paper selection will not operate correctly. Printing may take place on the wrong size or type of paper or a misfeed may occur.

6. Update the system settings via the touch panel of the printer.

3.2.5. Loading Paper in the Bypass Tray (Option)

Up to 100 sheets plain paper can be loaded to the manual feeder MX-MFX1 (called semi magazine or bypass tray). Up to 500 sheets can be loaded to the manual feeder MX-MF11 which was designed to be used together with the large capacity trays.

This large paper capacities make uninterrupted printing possible – here the bypass trays are comparable to other trays of the printer.



In the following figures a bypass tray mounted to a large capacity tray is shown. The descriptions and elucidations can be used analogical for a manual feeder mounted to the basic device.

1. Press the push button to lower the paper table of the bypass tray.

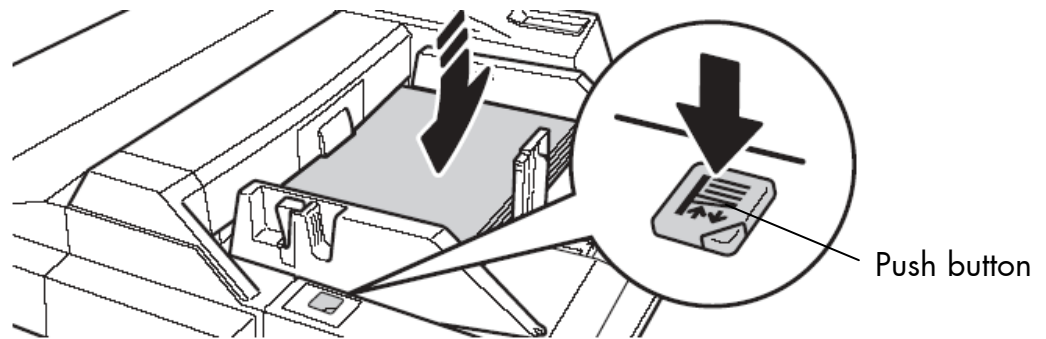

Fig. 3.2.5.a Lowering the paper table of the bypass tray

While the paper tray descends, the operation button indicator will blink. After the paper tray finishes descending, the indicator will light constantly.

Do not remove the paper until the indicator Stops.



Do not place heavy objects on the bypass tray or press down on the tray.

2. If you are changing the paper in the bypass tray, press the operation button and remove the previously used paper.
3. Press the bypass guide lock lever and “open” the paper guides for the print media to be used. (Slide the paper guides to the edges of the bypass tray.)

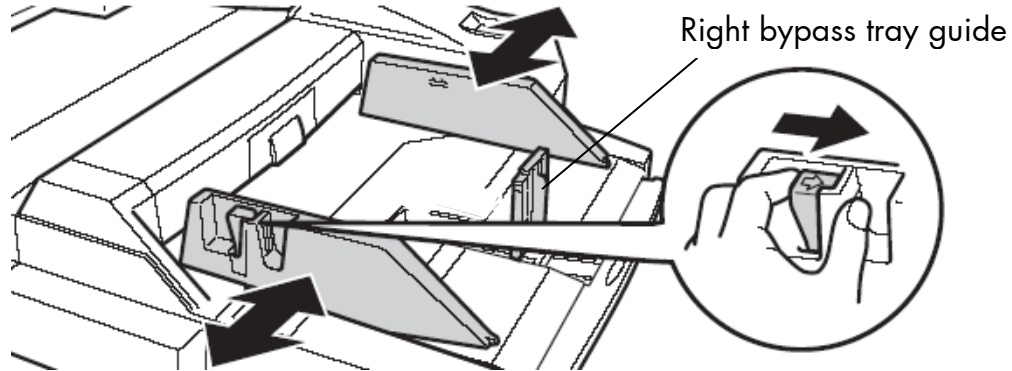

Fig. 3.2.5.b Unlocking and adjusting the paper guides

4. Set the paper guides to the new width of the print media and then release the bypass guide lock lever.
5. Set the right bypass tray guide to the size of the new print media, too (compare fig. 3.2.5.b; you have to press the lock lever of this guide during the setting procedure).



If you want to load a greater print media size, removing the right bypass tray guide (bottom edge) may be necessary. Please grasp this guide, tilt it a little bit and then pull it up to remove it (compare figure 3.2.5.c). Now you can reinstall the guide in accordance to your new print media size (the guide has to be tilt a little bit for installation, too).

6. When loading paper larger than 8-1/2"x11"R or A4R, be sure to pull out the bypass tray extension. Now you are able to assemble the bypass tray guide in the right position according to your new print media size.
(Note: Pull the bypass tray extension all the way out. If the bypass tray extension is not pulled all the way out, the size of the loaded paper will not be correctly displayed.)
7. If you want to load even larger paper sizes, please remove the bypass tray guide from the printer and store it. It has to be reassembled as soon as smaller paper sizes are used again.

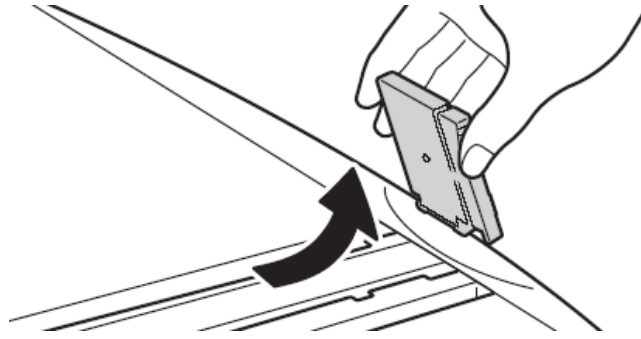

Fig. 3.2.5.c Removing the right bypass tray guide (only if need be; compare above)

8. Flex the sheets back and forth to loosen them, and then fan them. Do not fold or crease the print media.

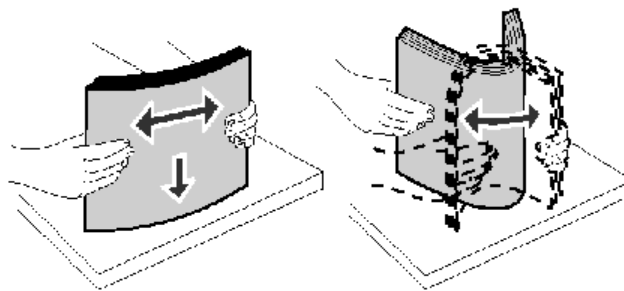

Fig. 3.2.5.d Fanning and aligning the paper pile

9. Straighten the edges of the stack on a level surface.



Do not load bent or wrinkled print media.

Load the paper with the **print side face up** in the bypass tray.

10. Place the print media along the front side of the paper table of the bypass tray. Push the print media gently in as far as it will go.



When loading paper, make sure that the paper guides are correctly adjusted to the width of the paper.

If there is a gap between the paper and the guide, or if the paper is bowed because the guide is adjusted to a narrower width than the paper, a misfeed, skewed paper feeding, or creases in the paper may result.

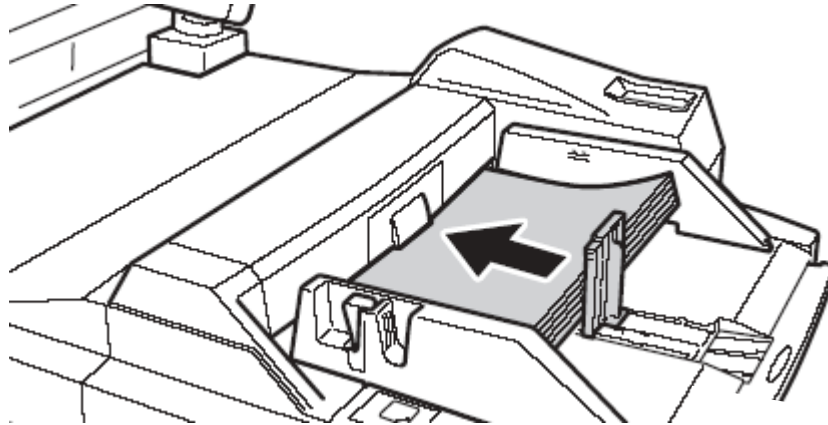

Fig. 3.2.5.e Pushing the print media along the paper guides of the bypass tray



Do not exceed the maximum stack height indicated on the paper guide. Overfilling the feeder may cause paper jams.

11. Slide the right bypass tray guide towards the stack (see the following figure) until it lightly touches the stack of print media.

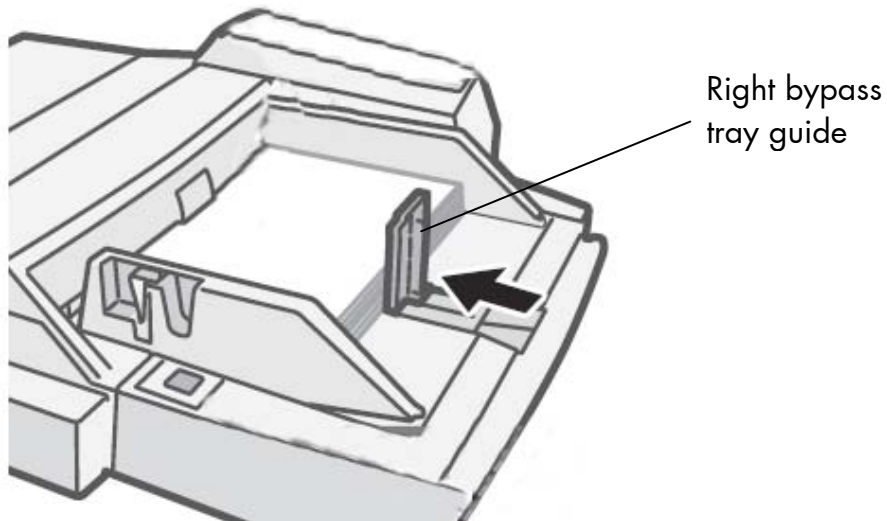

Fig. 3.2.5.f Gently slide the right bypass tray guide towards the paper stack

12. Press the push button in order to rise the paper table.

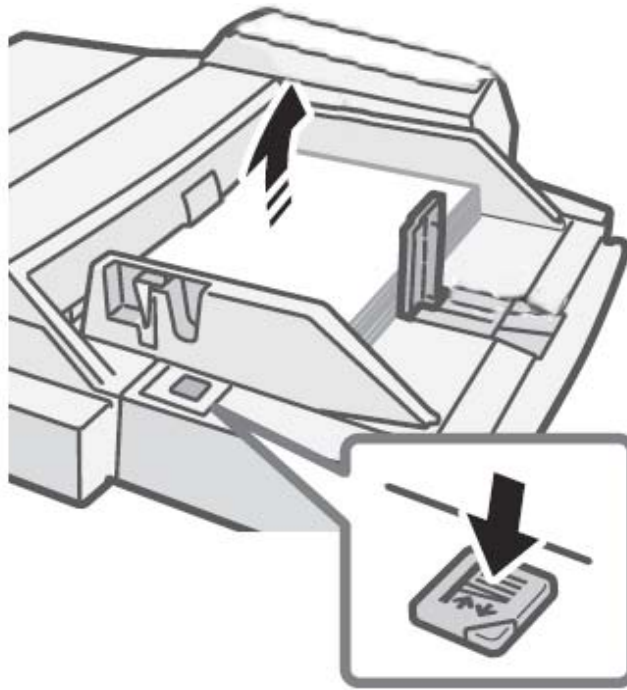

Fig. 3.2.5.g Rising the paper table of the bypass tray



While the paper table rises, the operation indicator blinks.
After the paper tray finishes rising, the indicator will stop blinking.

Updating the System Settings



Always take care that the settings of the device match the paper that you loaded.

If, for example, the **paper type** setting is not configured correctly, automatic paper selection will not operate correctly. Printing may take place on the wrong size or type of paper or a misfeed may occur.

13. Update the system settings via the touch panel of the printer.

4. Operation and Menu Structure



The printer's first installation has to be done by a trained service engineer.

4.1. Attaching the Printer to a Network/PC and to the Power Supply



Fig. 4.1.a Rear view of the SOLID 90 A3, 105 A3 and 120 A3 print system

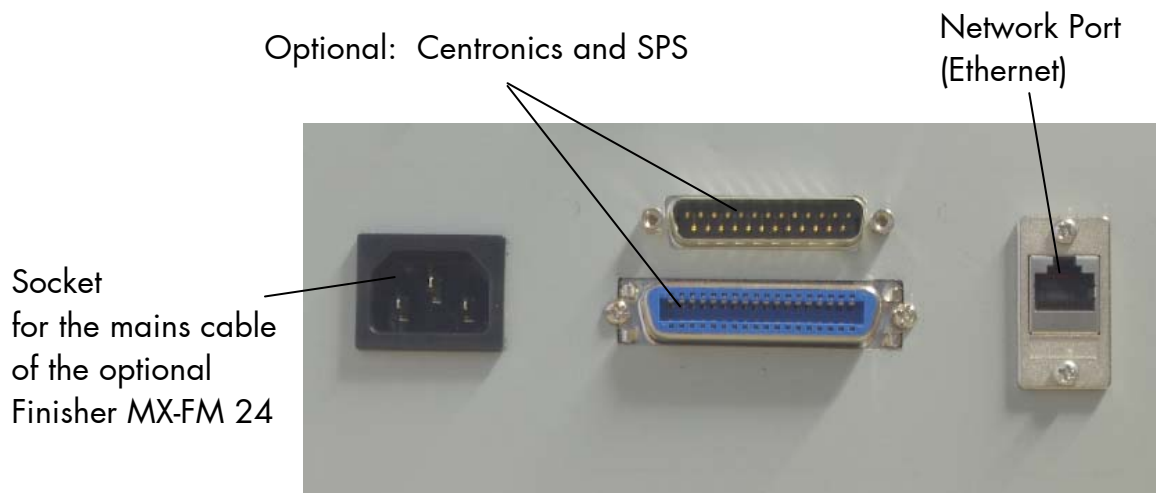

Fig. 4.1.b Details: Interfaces of the SOLID 90 A3, 105 A3 and 120 A3

1. Make sure the print system (SOLID 90 A3, 105 A3 and 120 A3), the computer, and any other attached devices are turned off and unplugged.
2. Use a proper interface line to connect the printer SOLID 90 A3, 105 A3 and 120 A3 to your computer or to the network.
3. Plug the end of the printer power cord into a properly grounded outlet. (The power cord is located at the back of the printer.)

4.2. Print System Power On

The SOLID 90 A3, 105 A3 and 120 A3 print system has two power switches. Turning the power on is described below (use the reverse steps to turn the power off):

1. Open the front cover of the device.

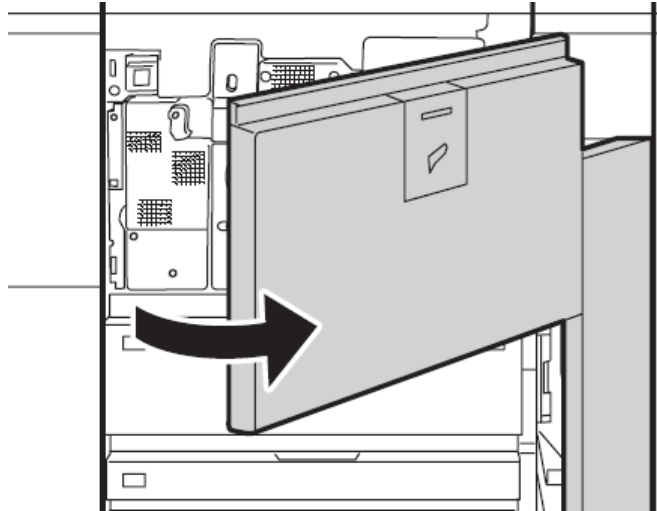

Fig. 4.2.a Opening the front cover of the device

2. Turn on the main power switch.



Fig. 4.2.b Switching on the printers main power switch (power supply switch)

3. Turn the ON/OFF key to ON (located at the lower right corner of the operation panel).

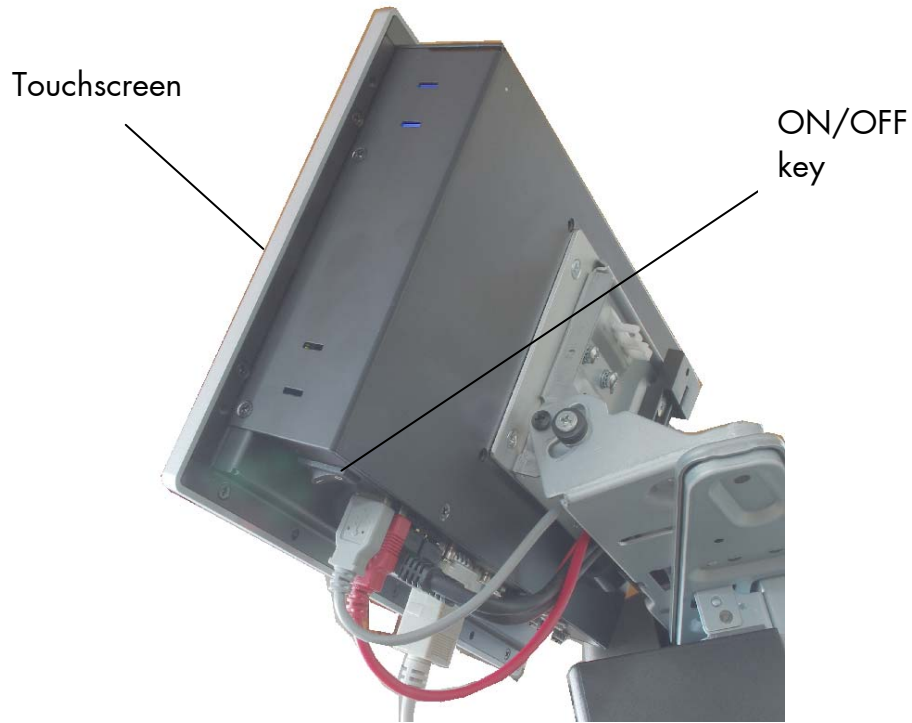

Fig. 4.2.c ON/OFF key (located at the operation panel of the device)



The print system requires time to initialize and to warm up after you turn it on.

Turning off the print system

4. Before turning off the print system, make sure that a job is not in progress or being processed.
5. Turn the On/Off switch to OFF. (The location of the switch at the touch panel is shown in figure 4.2.c.)
6. Turn off the main power switch of the device. (The location of the main power switch is shown in figure 4.2.b.)



Switch off both the ON/OFF switch (located at the lower right corner of the operation panel) and the main power switch and unplug the power cord of the print system if you suspect a machine failure, if there is a bad thunderstorm nearby, or when you are moving the device!

4.3. Operation Panel of the Device

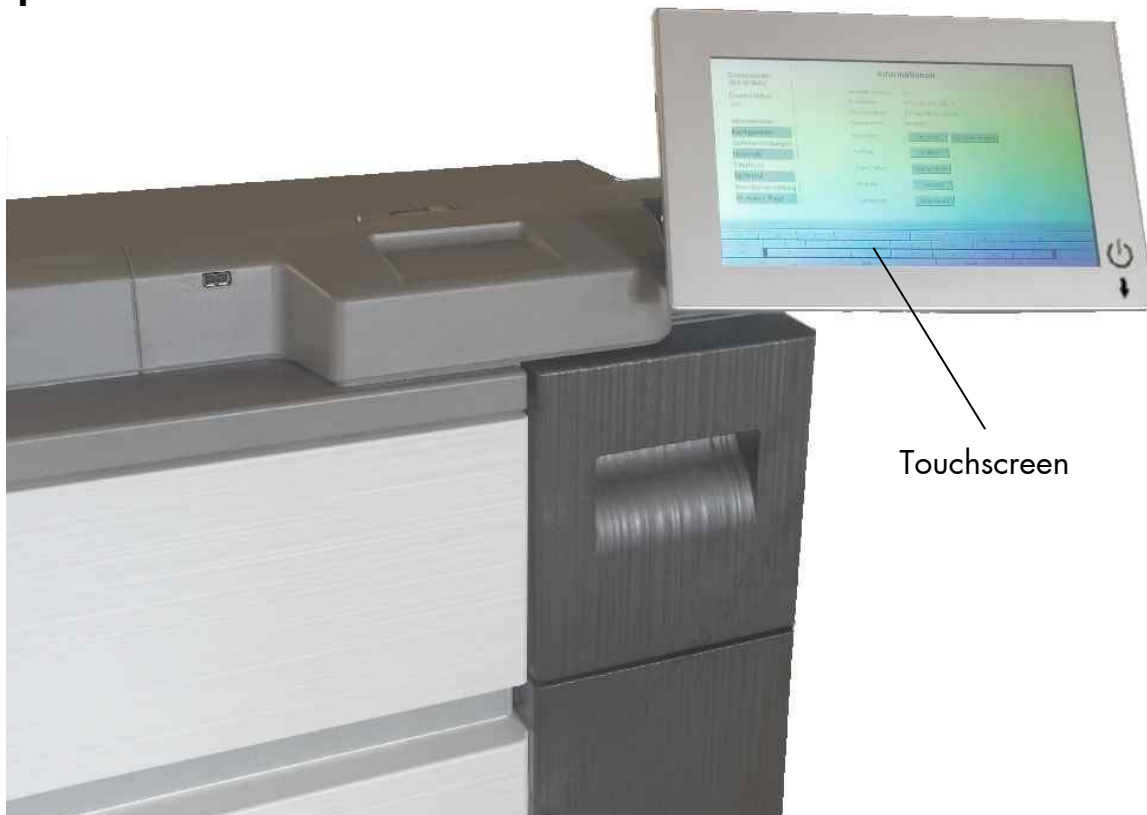

Fig. 4.3.a Operation Panel of the SOLID 90 A3, 105 A3 and 120 A3 (Touchscreen)

The touchscreen displays the windows to perform a variety of device operations. Status messages of the device are displayed here, too.

MICROPLEX provides you two variants of user interfaces for the SOLID 90 A3, 105 A3 and 120 A3: the **WebPanel** and the **IP-Panel**.

The **WebPanel** presents the configuration opportunities of the printer as a „page-oriented“ application.

IP-Panel presents a **virtual control panel** of the SOLID 90 A3, 105 A3 and 120 A3, as you know it from other MICROPLEX printers.

Note:

Both variants of the user interfaces are provided for remote controlling the SOLID 90 A3, 105 A3 and 120 A3.

The **presentation on the touchscreen** at the printer **and** the presentation via **web browser** during remote controlling is **comparable**.

The display screens, messages, and key names shown in the manual may differ from those on the actual machine due to product improvements and modifications.

4.4. WebPanel User Interface

4.4.1. Using the Touchscreen

The touchscreen displays the windows to perform a variety of device operations. The screen serves to show the printer's status messages, too.

You can change printer settings by „clicking“ the input fields on the touchscreen (touching the screen with your finger tip):



The print system settings can only be changed if the **printer** is turned **OFF LINE**.

To change a parameter, „click“ on this specific parameter:

Select for example ConfigType Manual and then click the input field for the IPAddress. (More details about the Network Page are described in section 4.4.5.)

You can use the „keyboard keys“ at the bottom of the touchscreen to enter a new function value (the numbers are available after clicking the ?123 button).

Complete the input of the function value with the Submit key.

The print system confirms the acceptance of the new setting value. (An improper setting value leads to an error message).

4.4.2. Information Page

After the printer is powered On the touchscreen at the printer shows the Information page (corresponds to the WebPanel presentation in the browser). On the Information page the printer status is displayed, as well as information on the controller and firmware version of your device.

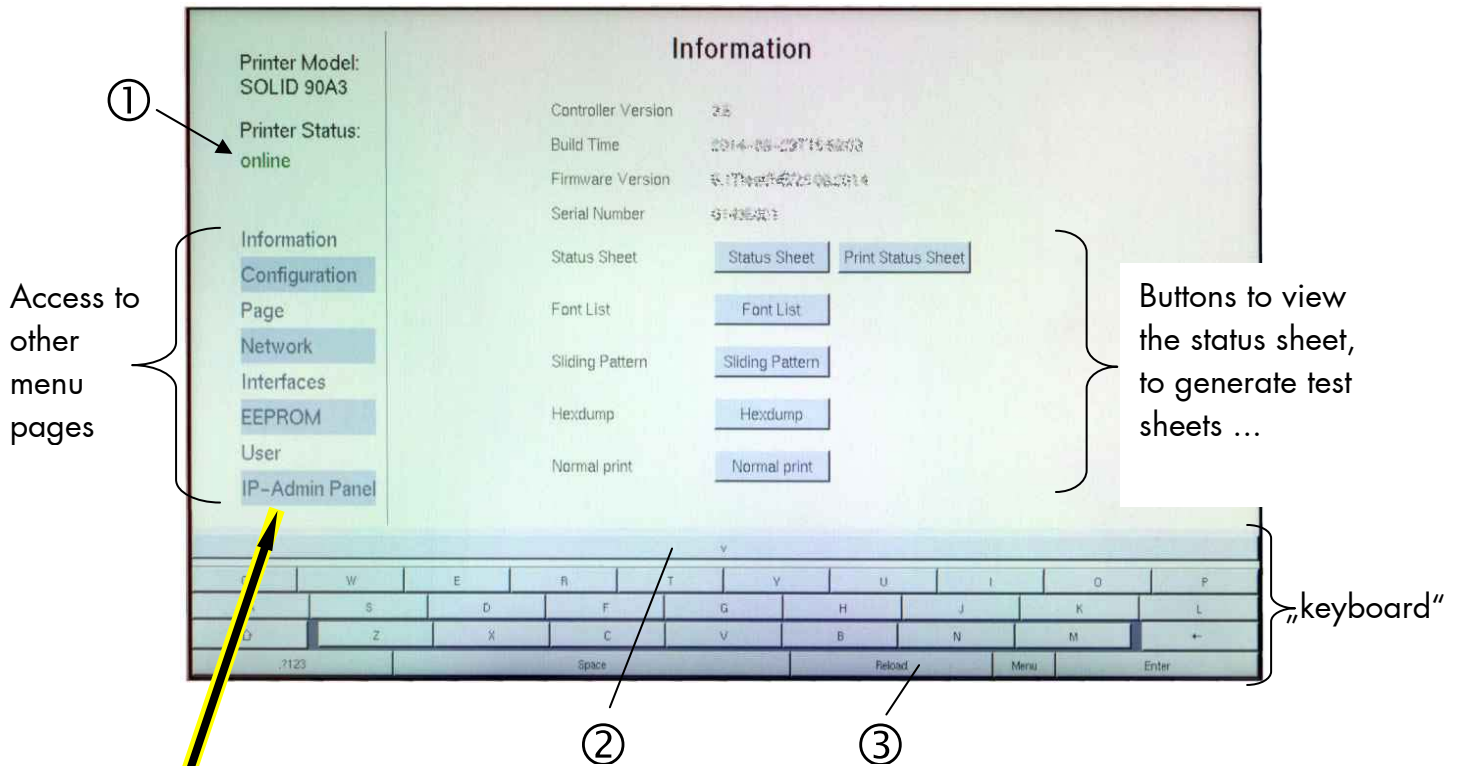

Fig. 4.4.2.a Touchscreen of the SOLID 90 A3, 105 A3 and 120 A3: Information page

Hints:

① Touching the status message turns the printer offline/online („single click“ on the status message, compare ① in the figure above.)

By „touching“ the IP-AdminPanel button you can switch to the **IP-Panel user interface** directly („panel“ as you know it from other MICROPLEX printers, see section 4.5 IP-Panel User Interface).

② The keyboard in the lower area can be minimized by touching the key V. (To maximize the keyboard, please touch the key A).

③ Touching the Reload button releases a updating of the screen display.

4.4.3. Configuration Page

On the Configuration page a number of print system configuration parameters can be changed.

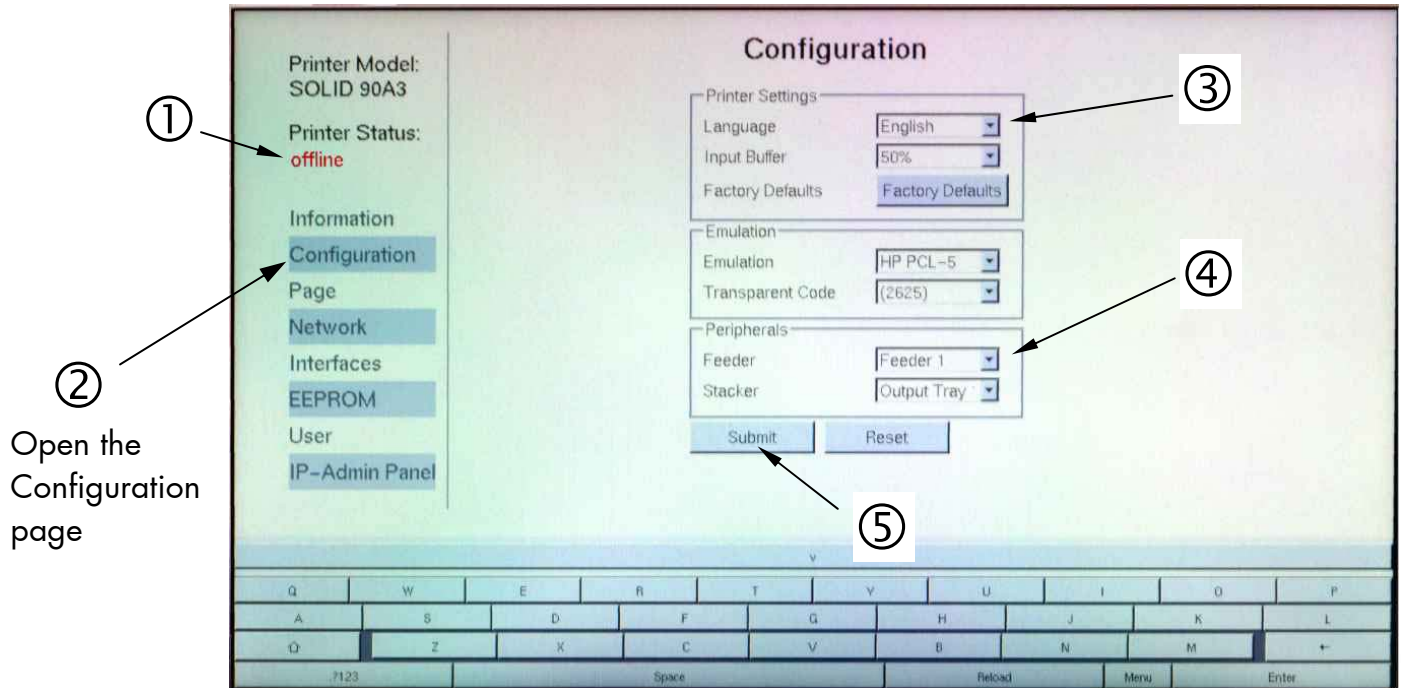

Open the Configuration page

Fig. 4.4.3.a Configuration menu page on the touchscreen of the SOLID 90 A3/105 A3/120 A3

Abstract:

Please „click“ on the parameter you wish to change:
(this means that you have to touch the touchscreen at this very spot)

- ① Click on the „online“ status message to turn the printer offline.
(Clicking on the „offline“ message turns the printer online again).
- ② Click on „Configuration“ to get to the Configuration page.
- ③ Click the input field for the Language to change the language of the display messages, the status sheet...
- ④ Click the input field for the Feeder. This enables you to select the paper source (the paper is picked up from the selected feeder/cassette).
- ⑤ Click the Submit button to finalize your settings.



The following descriptions of panel functions are written assuming the printer is turned **OFFLINE**.

4.4.4. Menu Page for Page Configurations

On this menu page you can for example set the paper size and the margins of the print pages.

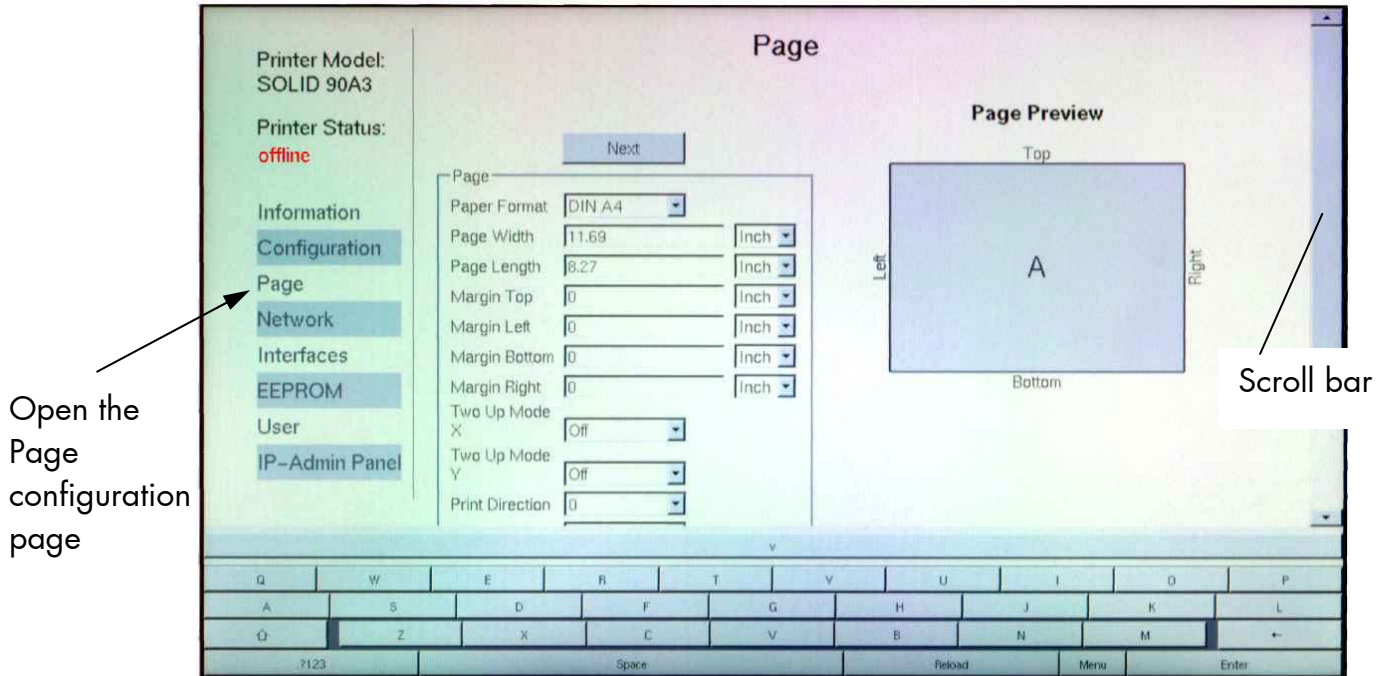

Fig. 4.4.4.a Page configurations on the Touchscreen of the SOLID 90 A3/105 A3/120 A3

Please use the scroll bar at the right side of the screen to make the lower part of the menu page visible:

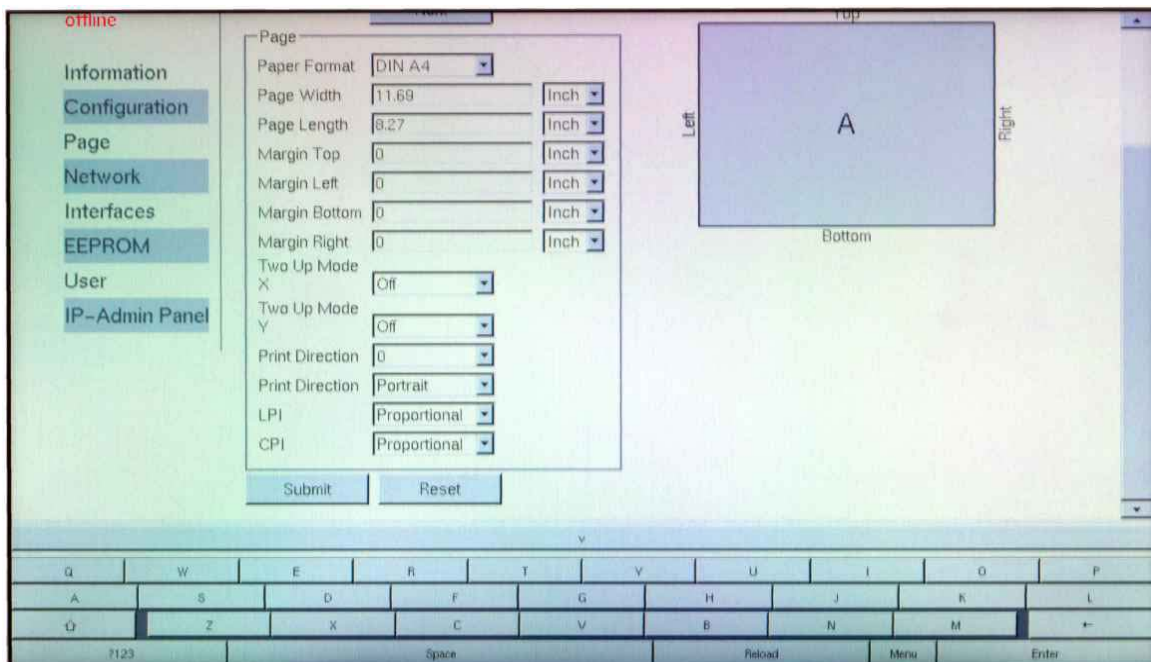

Fig. 4.4.4.b Lower part of the menu page

4.4.5. Network Page

On the Network page you can configure the parameters for a network connection of the printer.

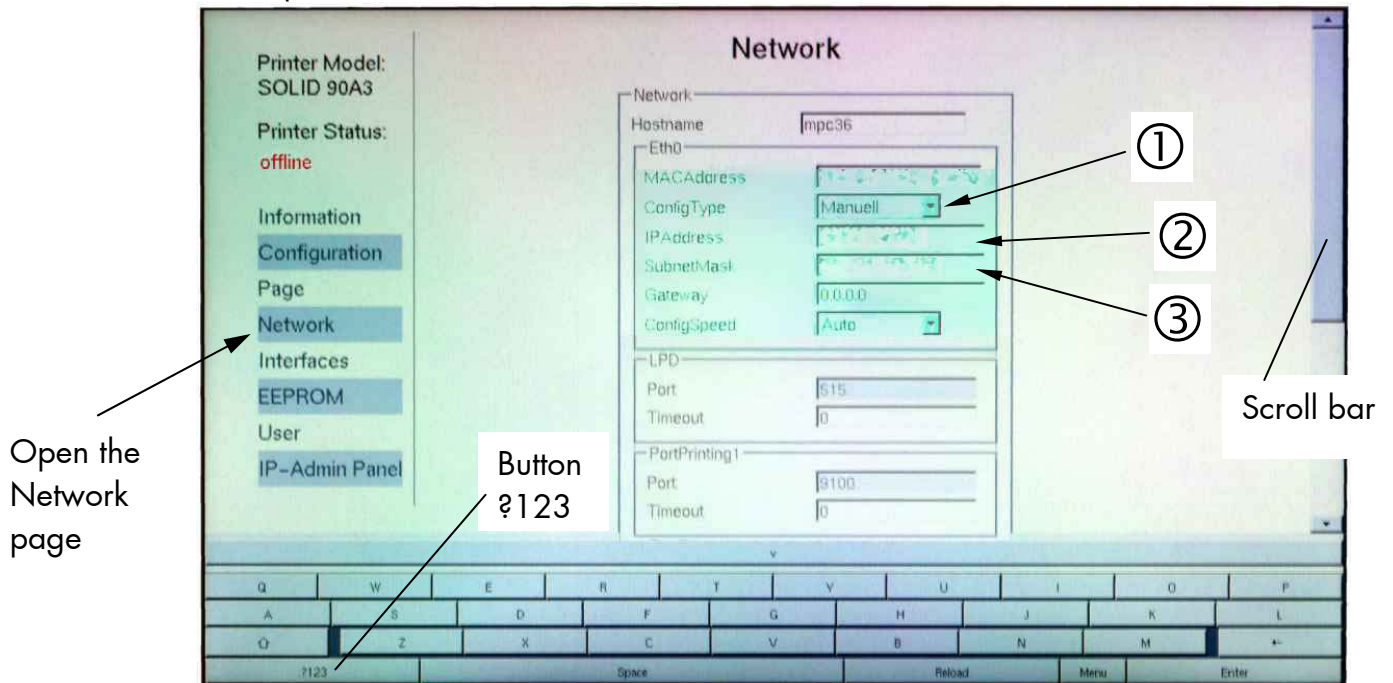

Fig. 4.4.5.a Network menu page on SOLID 90 A3/105 A3/ 120 A3 Touchscreen

Please use the scroll bar at the right side of the screen to make the lower part of the Network page visible:

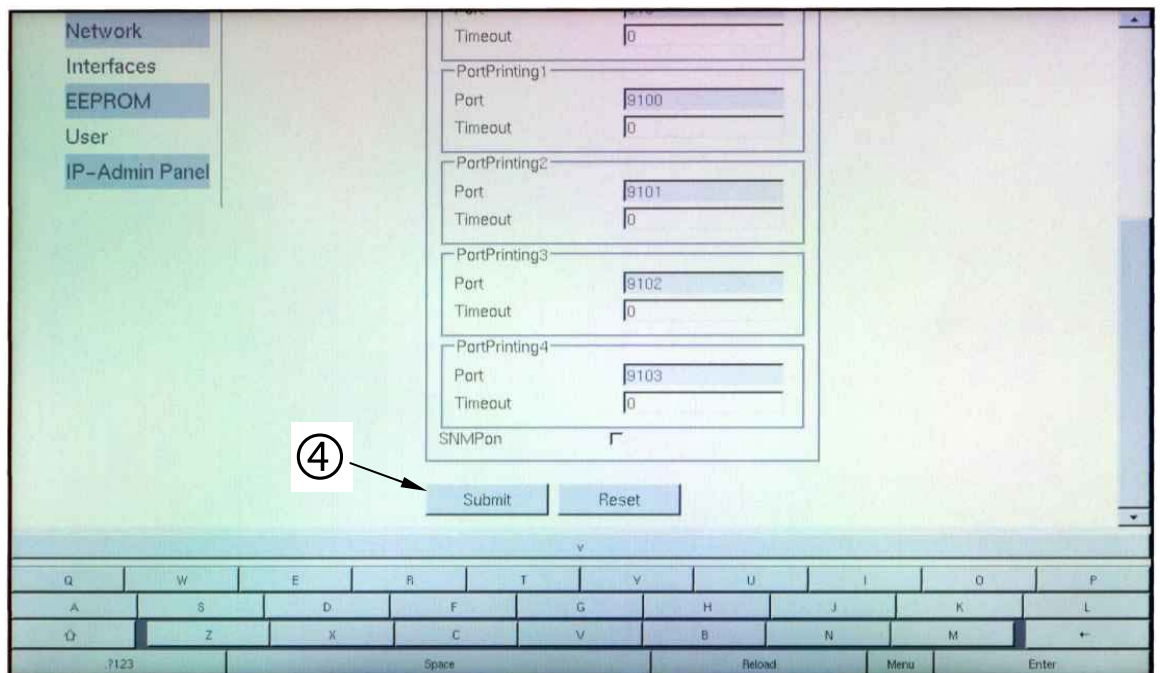

Fig. 4.4.5.b Lower part of the Network menu page

Abstract:

Please „click“ on the parameter you wish to change:

① Select for example ConfigType Manual.

② Click the input field for the IPAddress.

Use the „keyboard keys“ to enter the IPAdresse (the numbers are available after clicking the ?123 key).

③ Click on the input field for the SubnetMask and enter the subnet mask.

④ Click the Submit button to finalize your settings.

More details on the network parameters can be found in chapter 5 Panel Functions.

4.4.6. Interfaces Page

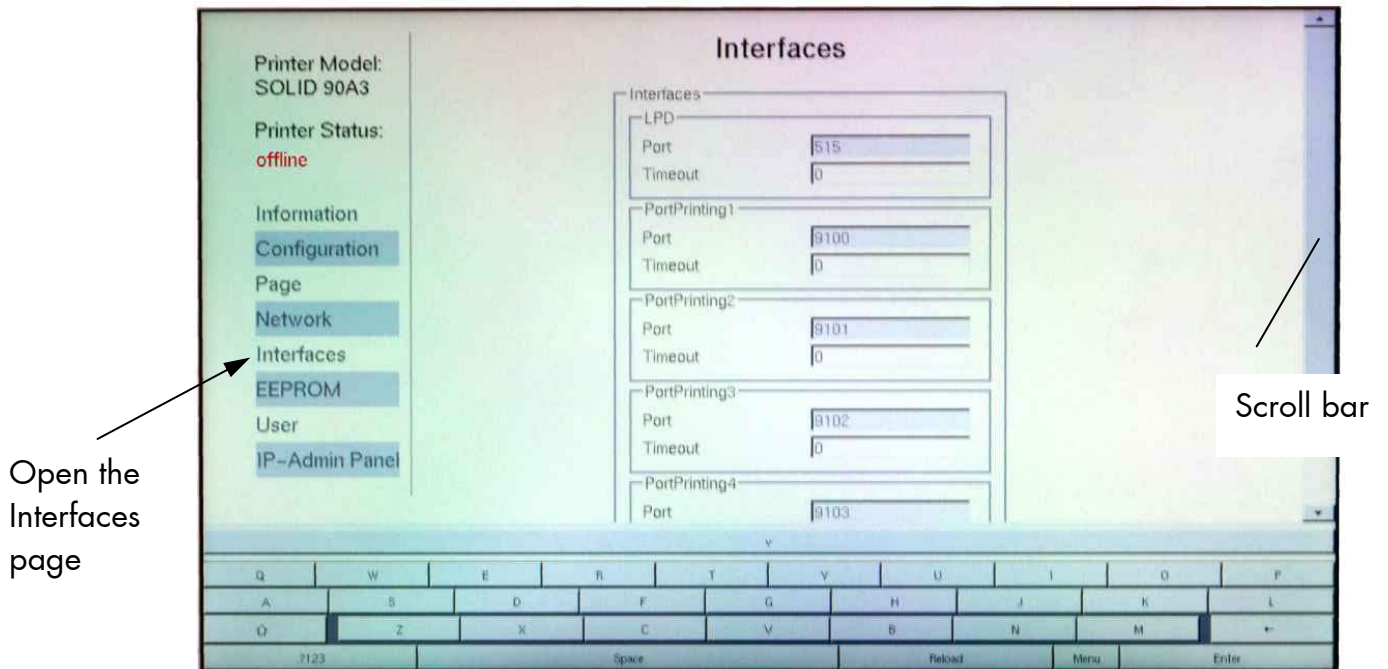

Fig. 4.4.6.a Interfaces page on the SOLID 90 A3, 105 A3 and 120 A3 Touchscreen

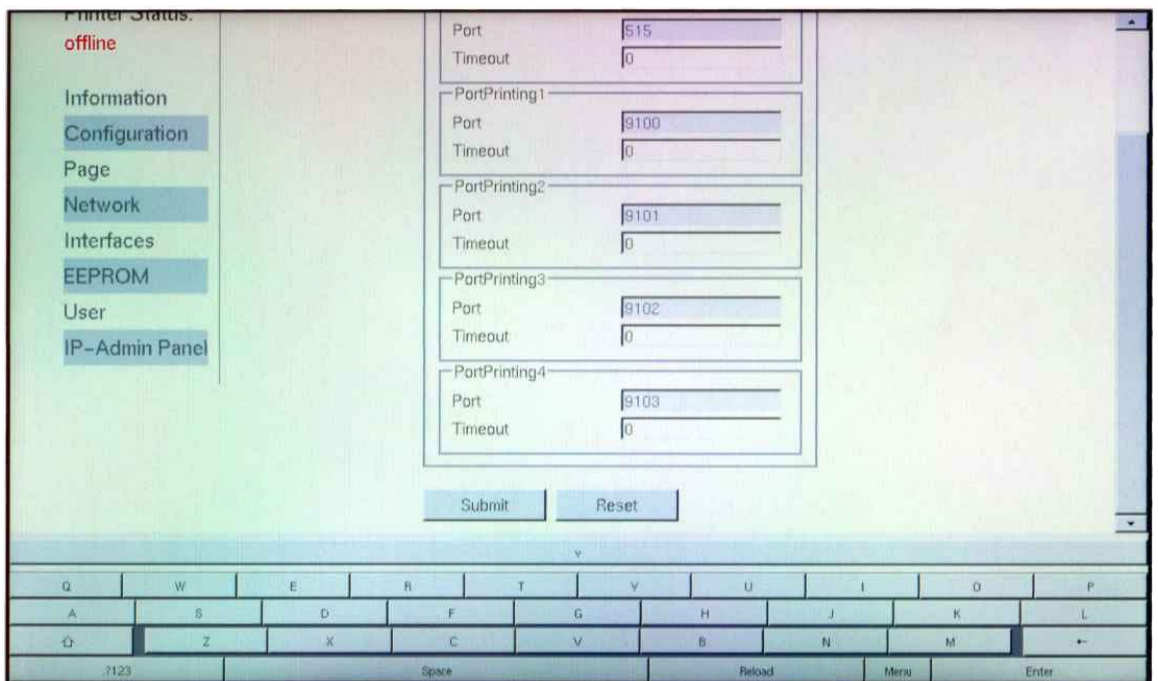

Fig. 4.4.6.b Lower part of the Interface menu page

More details on interface parameters can be found in chapter 5 Panel Functions.

4.4.7. EEPROM Page

Attention:

You have to be **very careful** when changing parameters via the EEPROM page. If you use wrong parameters, the printer could hang up!

Before you change EEPROM parameters of the print system it is recommended to print a **Status Sheet!** This facilitates a reset of the printer (resetting the parameters to the former settings).

The parameters must be written in hexadecimal numbers (0000 to FFFF). These EEPROM values are printed out in the first to third line of the Status Sheet.

The fourth line (Word 49 to Word 64) cannot be programmed by the user.

Hint:

For more details refer to our offer of **MICROPLEX Training Courses** and the corresponding documentation "The EEPROM-Sequence".

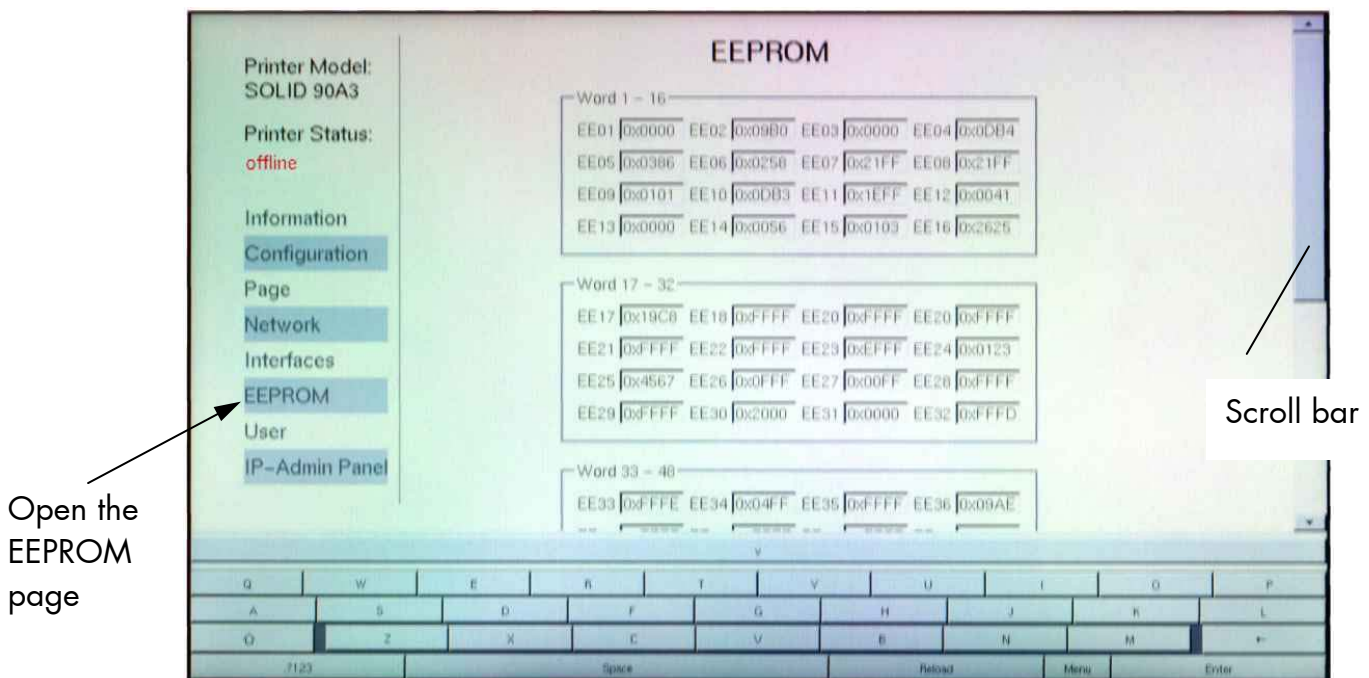

Fig. 4.4.7.a EEPROM page on the SOLID 90 A3/105 A3/120 A3 Touchscreen

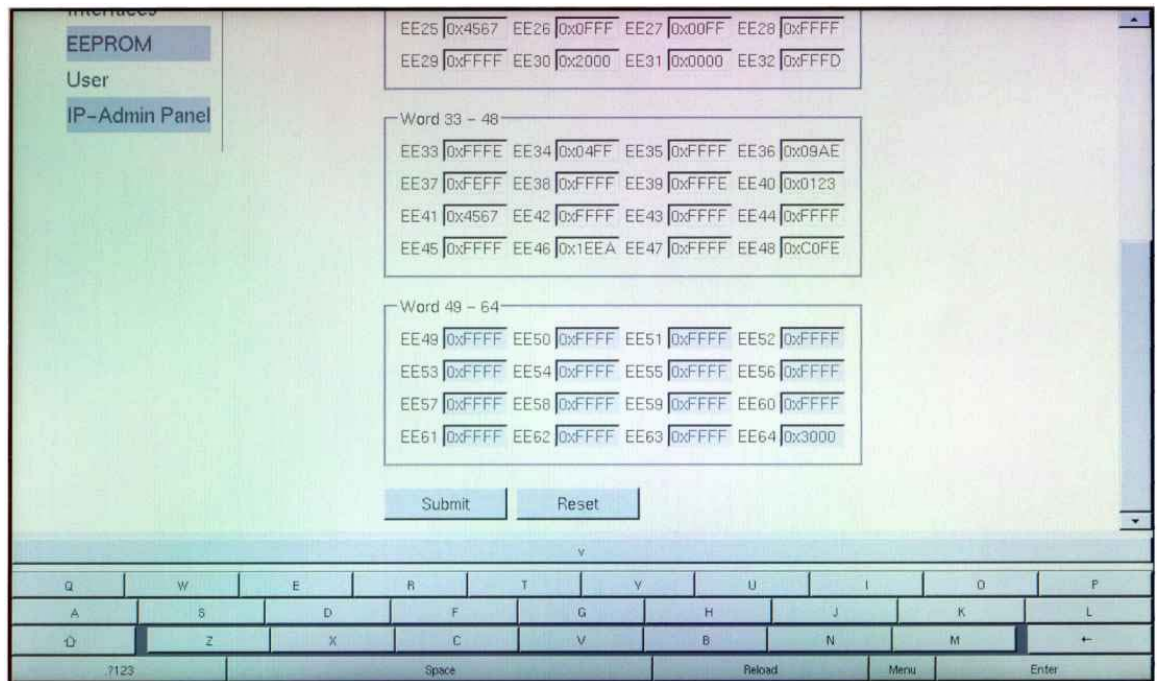

Fig. 4.4.7.b Lower part of the EEPROM menu page

Feature (specially for the EEPROM page):

The print system confirms the acceptance of the new setting value by displaying the setting value in green color. (If the setting value is not ok, the color changes to red.)

4.4.8. User Page

This menu page can be used to enter all users of the print system (entry of user name and password).

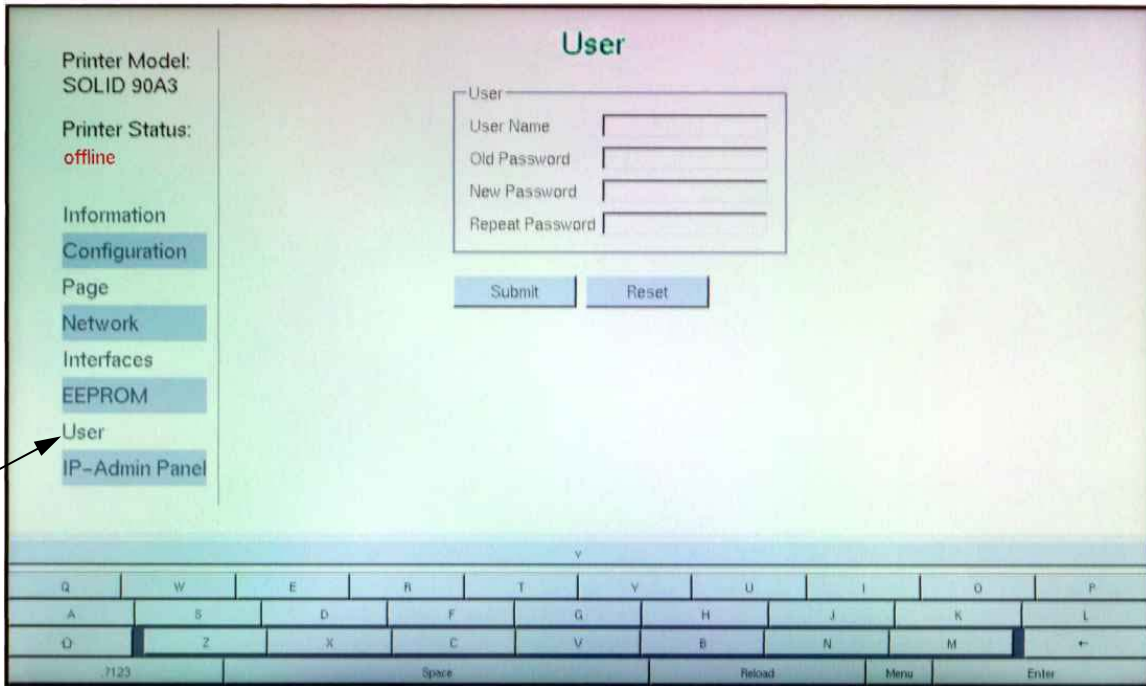

Open the User page

Fig. 4.4.8. User page on the SOLID 90 A3, 105 A3 and 120 A3 Touchscreen

4.5. IP-Panel User Interface

If you are already familiar with the panel functions of MICROPLEX printers the IP Panel enables you to do the well-known operating steps.

After the printer is powered On the touchscreen shows the Information page (WebPanel).

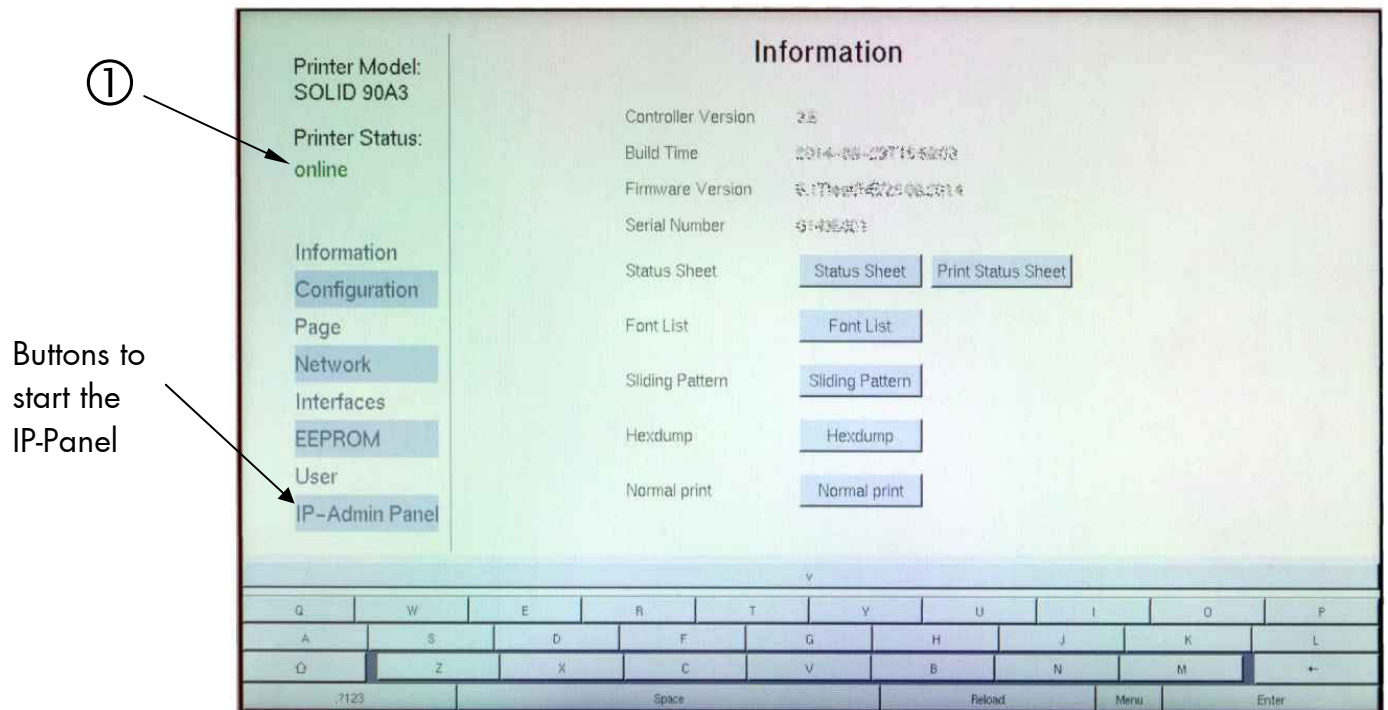

Fig. 4.5.a Touchscreen of the SOLID 90 A3, 105 A3 and 120 A3: Information page

How you can switch to the IP-Panel user interface:

1. „Touch“ the „online“ status message to turn the printer offline („single click“ on the status message, compare ① in the figure above.)
2. Click on the IP-Admin Panel button (see figure above).

The **virtual panel** (internal web page of the printer) of the SOLID 90 A3, 105 A3 and 120 A3 is displayed.

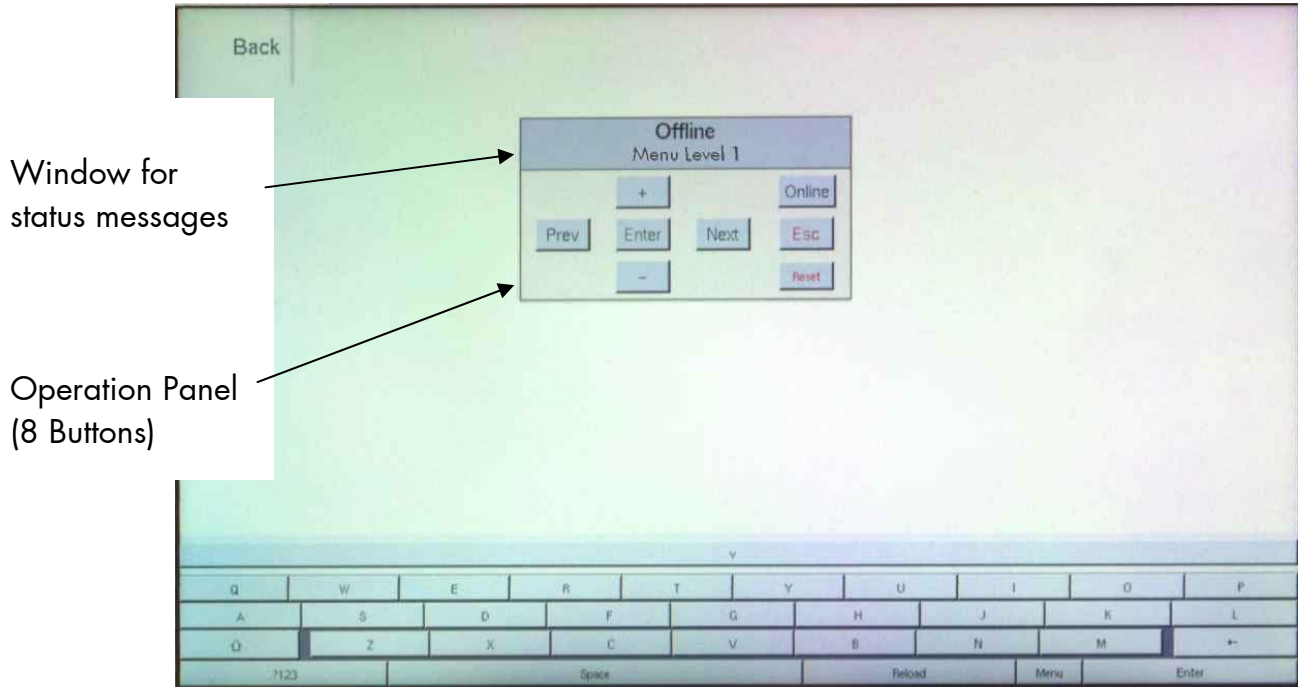

Fig. 4.5.b IP-Panel User Interface on the touchscreen of the SOLID 90 A3/ 105 A3/120 A3

Details about the panel functions can be found in the following sections.

4.6. Remote-Controlling the SOLID 90 A3

4.6.1. Abstract

You can also access the SOLID 90 A3, 105 A3 and 120 A3 remotely. The internal web page of the printer enables you for example to control or configure the printer using a computer that is connected via Ethernet (MICROPLEX IP-Panel and WebPanel).

1. Connect the SOLID 90 A3/105 A3/120 A3 to your network* (via the Ethernet port, compare section 4.1 Attaching the Devices to a Network/PC).

The following network parameters** are for instance factory default settings:

IP Address	192.168.128.128
Subnet mask	255.255.255.0
Gateway	0.0.0.0

2. Start your Web Browser and type the IP address of the printer in the address bar of the Web browser:

http://192.168.128.128/

The Web Browser shows the Information page of the MICROPLEX WebPanel:

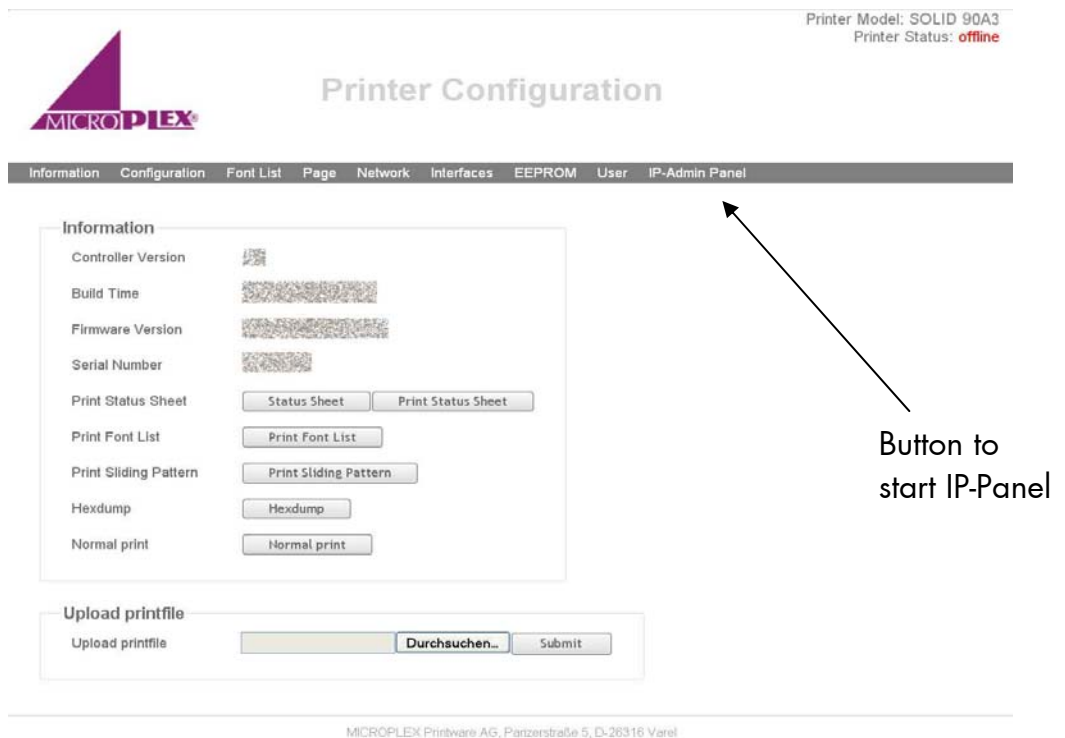

Fig. 4.6.1.a Screenshot of the MPX WebPanel User Interface: Information page

Hint:

Descriptions of using the IP-Panel prevail in the following sections.

If you are already familiar with the panel functions of MICROPLEX printers the IP-Panel enables you to do the well-known operating steps.

3. Please start IP-Panel (click on the button at the upper right).

The **virtual control panel** (internal web page of the printer) of the SOLID 90 A3, 105 A3 and 120 A3 pops up:

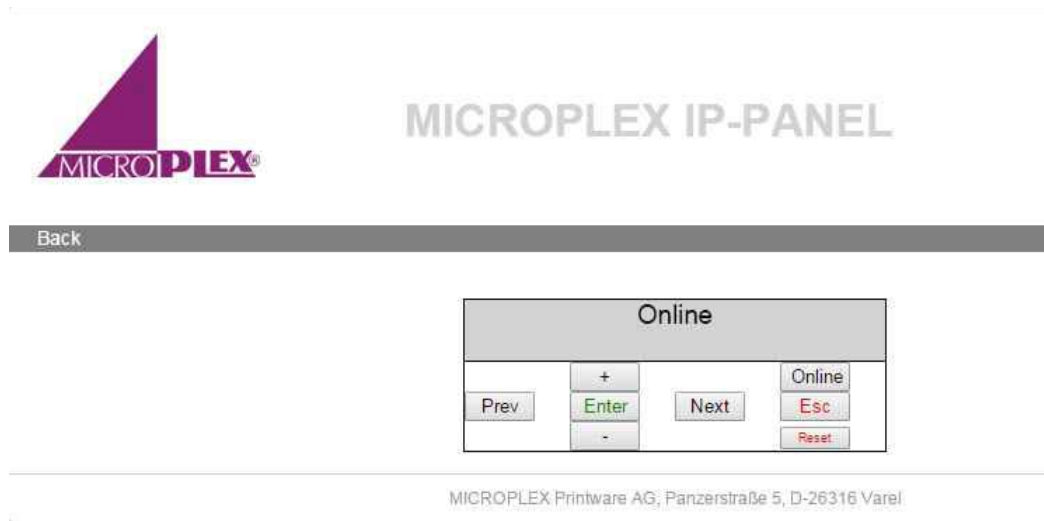

Fig. 4.6.1.b MICROPLEX IP-Panel (virtual control panel of the SOLID 90 A3/105 A3/120 A3)

This virtual control panel enables you to get access to the printer's menu structure. Details about the panel functions of the printer can be found in the following sections of this manual.

- * More details are described in the document [Networking Features of MICROPLEX Printers](#). You'll find this document on the MICROPLEX Documentation CD. The CD belongs to the extent of supply of your printer.
- ** The network settings can be changed.
(See section 5.28 Configuration of Network Parameters).
The **status sheet** of the SOLID 90 A3/105 A3/120 A3 shows the **current settings**.

4.6.2. Details of the IP-Panel Elements

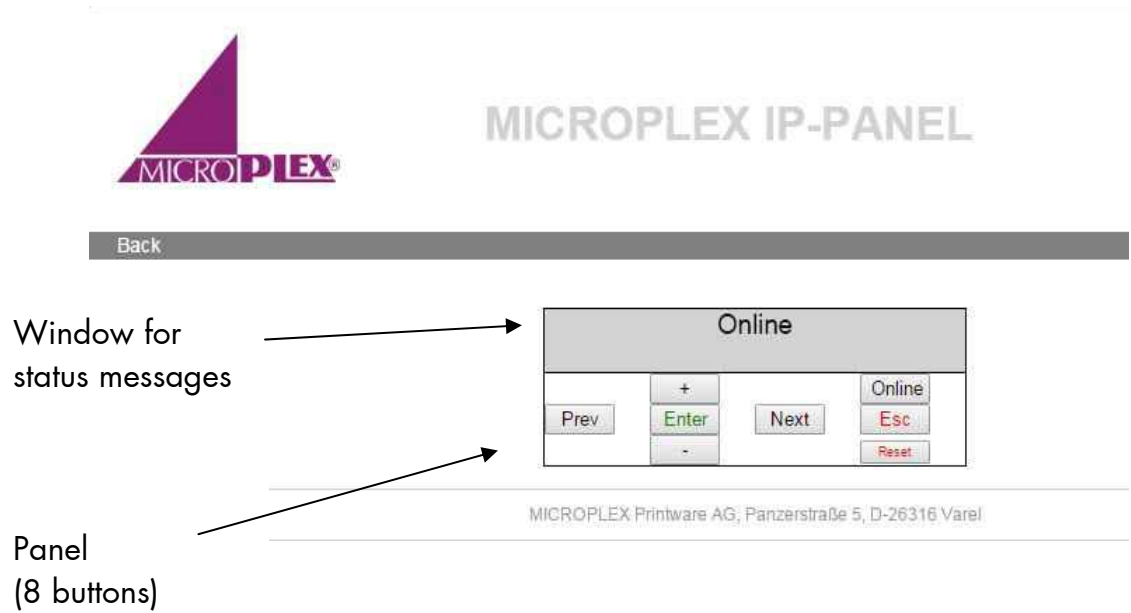



Fig. 4.6.2.a MICROPLEX IP-Panel (virtual control panel of the SOLID 90 A3, 105 A3 and 120 A3)

Buttons („Panel keys“)



The  key turns the printer ON / OFF LINE.



These keys are used for working within the different levels of the menu structure.

This structure and the panel functions are described in the following.

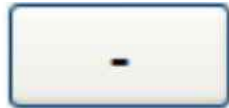



Using this key a RESET is released in the OFF LINE mode. You can back out e.g. error messages by a RESET.

4.7. Configuration via the Control Panel

You can use **IP-Panel** and **WebPanel** directly on the touch panel of the SOLID 90 A3/105 A3/120 A3 or for remote-controlling via network to change the printer configuration and customize your device to meet your specific needs.

Chapter 5 (Panel Functions) describes how to reach the particular printer functions via the control panel.

T e m p o r a r y changes in printer configuration are effective only as long as the printer stays turned on. To select such changes temporarily, the user must terminate the change of function by pressing the  key one single time.

P e r m a n e n t changes in printer configuration are active each time the printer is turned on again. To select such changes permanently, the user must terminate the change of function by pressing the  key **two times**.

An output of the current printer values can be generated using the panel function "Printing the Status Sheet " (see section 5.1).

4.8. Menu Structure

Access to the menu structure is possible as soon as the printer is turned OFF LINE. The menu structure of the SOLID 90 A3, 105 A3 and 120 A3 is arranged in different levels:

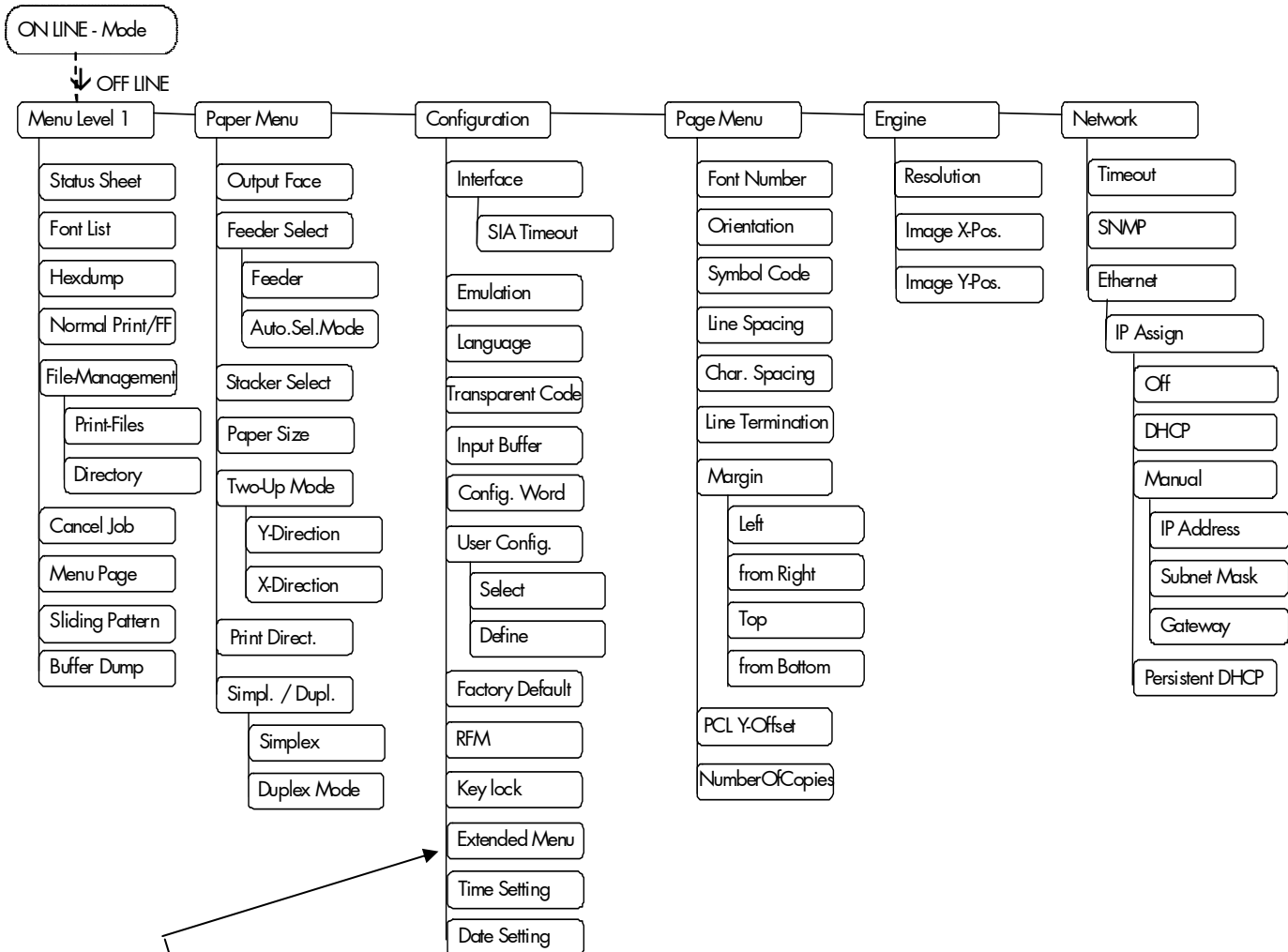

This panel function allows the user to choose a **reduced menu** instead of the extended menu shown above.

Selecting positions in the menu structure:

This symbol shows the  key. You get automatically into menu level 1, if the printer is turned OFF LINE with this key.

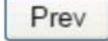

By pressing the  key or the  key you can move within the menu levels.

["Menu Level"]



Each menu item/subitem within a menu level is shown in the display.



The  key has two main functions. It gives the user access to a particular menu and, once in the menu, it allows the user to select a particular function.

["Function"]

Functions / Changing of function values:

In case of a multi-digit function value the  button or the  button are used to select the position within the function value to be changed (DIGIT).

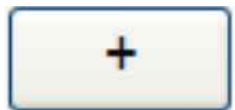

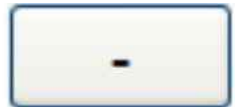

The buttons  und  change the value of the selected digit of the function value.





By pressing the  key the selected function is activated respectively the function values currently displayed are confirmed.



In case of a multi-digit function value pressing the  key switches to the next position of the function value.

Pressing the  key switches to the previous digit of the function value.

Please note: If you press the  key although the absolute left digit of the function value is still arrived, the changing procedure will be cancelled and this moves you to the next menu level above.

If you press the  key although the absolute right digit (digit 1) of the function value is still arrived, the currently displayed function value is stored.



Pressing the  key the displayed function value is confirmed respectively the displayed function is activated. The changes are saved temporary. (This means, the changes are saved only until the next printer power off).

[Save as Setup?]

After this you have to decide, if you want to save the changes permanent (Save as setup).



To select such changes permanently, the user must press the  key one more time. These permanent changes in printer configuration are active each time the printer is turned on again.



If the  key is pressed instead, the changes are only stored temporary (not saved as setup). (This key takes the user to the respective previous menu level).

Return to the menu level above:



Pressing the  key takes the user back to the respective menu level above.

Return to the ON LINE mode:

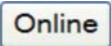

Pressing the  key switches the user directly to "ON LINE" from any menu position.





4.9. Syntax of Diagrams

The control panel functions will be described using diagrams. These diagrams show the course necessary in order to activate a certain function.

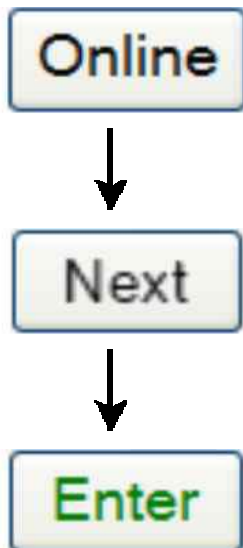
First the elements of the diagrams are explained:

The sequence on the left describes which keys have to be pressed briefly in succession.

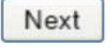
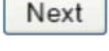

In this example the  key has to be pressed first. Then the  key has to be released and the  key has to be pressed. Then the  key has to be released and the  key has to be pressed.

["Message"]

The "Panel display" column shows the display messages corresponding to the sequences listed on the left.

In the column "Notes" explanations to particular operational steps are given.





5. Panel Functions



For the panel functions described in the following, the printer is presumed to be switched on and in the ON LINE mode.

5.1. Printing the Status Sheet

This function generates a status sheet. The status sheet contains information about the current printer configuration, the available fonts and options.

<u>Panel display</u>			<u>Notes</u>
[Online]		Turn the printer OFF LINE with this key.
[Menu Level 1]	↓ 	Press this key. Menu Level 1 is selected.
[Status Sheet]	↓ 	Press this key again.
[Status Sheet]	↓	A status sheet is printed.
[Online]		The printer is turned ON LINE again.

Status sheet contents:

The first lines, entitled SERVICE INFORMATION, contain hexadecimal coded configuration parameters.

Printed in plain text:







- Controller version / memory / serial number
- Firmware release
- Interface
parameters of Parallel, USB, Network (Ethernet)
- Network
parameters and addresses
- Printer emulation
- User-RAM / free User-RAM
- Input data buffer
- Transparent code
- Paper size
- Default margins top / left
 bottom / right
- Default character code
- Options
- Fonts installed (Font banks)

Note: Use the panel function Printing the Font List to show the fonts installed (see the following section).

5.2. Printing the Font List

This function generates a list of all fonts installed to the printer.

The font list shows demo prints of all fonts and, in addition, the concerning PCL selection commands. These commands contain information on font width and font height (see panel function Font Selection, too).

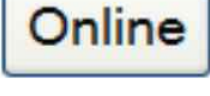
<u>Panel display</u>			<u>Notes</u>
[Online	1		Turn the printer OFF LINE with this key.
		↓	
[Menu Level 1	1		Press this key. Menu Level 1 is selected.
		↓	
[Status Sheet	1		Press the  or  key until [Font List] is displayed.
. . .			
[Font List	1		The font list is printed.
		↓	
[Font List	1		The printer is turned ON LINE again.
[Online	1		

5.3. Choosing Print Resolution

This function allows the user to choose the current print resolution.

If, after a particular resolution is chosen, the print data stream indicates a different resolution (e.g. via a WINDOWS print driver), the second print resolution will be used only for that job.

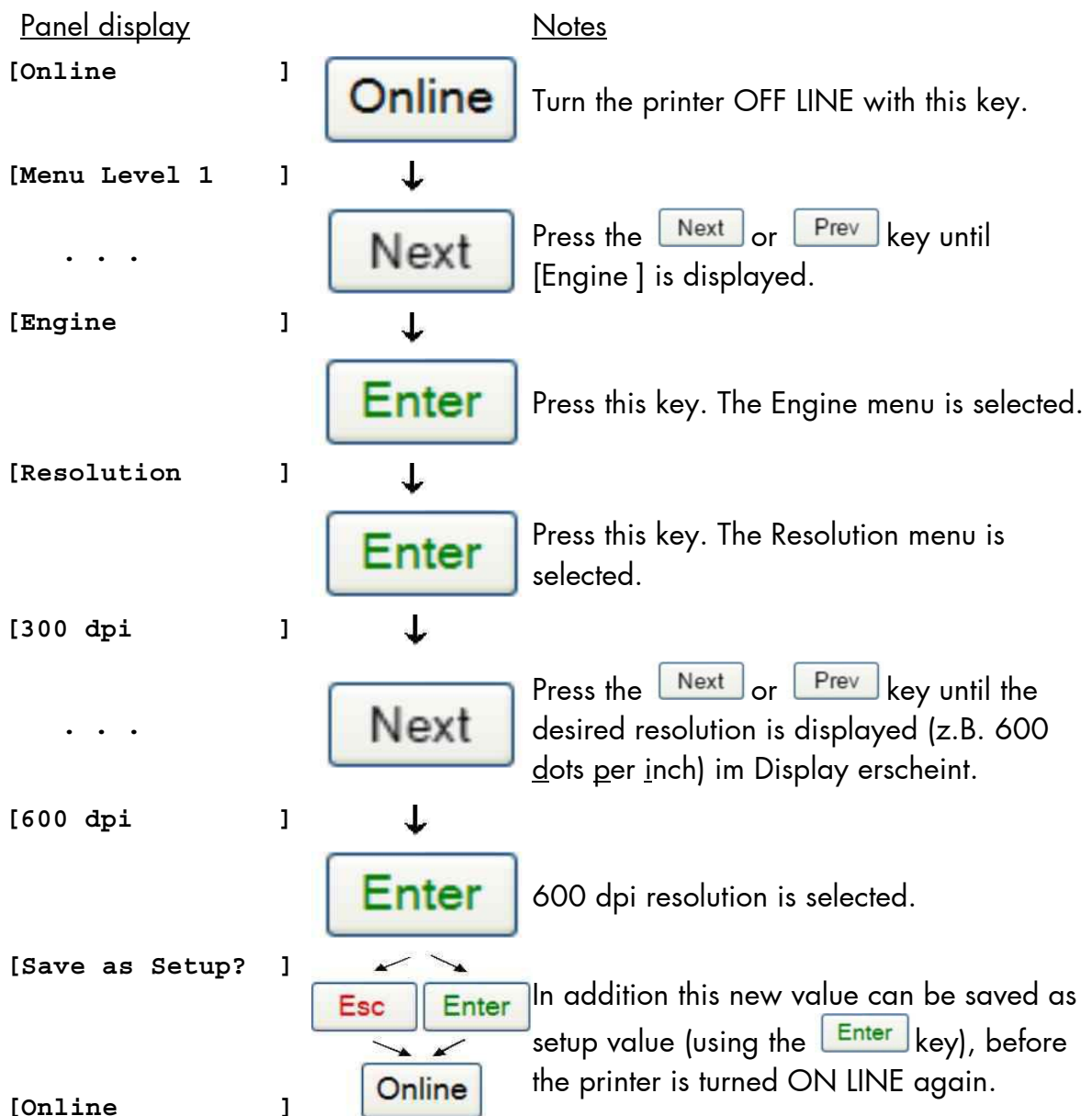

Remarks on choosing print resolution (Fonts):







By selecting 300 dpi resolution the printing system will be compatible for all applications (300 dpi data stream), also the 300 dpi font banks (bitmap writing) are available.

If 600 dpi resolution is chosen, the corresponding fonts must be loaded into the printer server (e.g. True Type fonts, scalable download fonts).

5.4. Hexdump Mode Activation

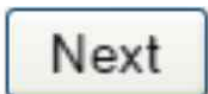
In the Hexdump Mode the printer prints all characters received via interface without any interpretation (hexadecimal coded).

This mode helps with error diagnosis. The Hexdump Mode can be activated only temporarily.







<u>Panel display</u>		<u>Notes</u>
[Online] 	Turn the printer OFF LINE with this key.
[Menu Level 1] ↓ 	Press this key. Menu Level 1 is selected.
[Status Sheet] ↓ 	Press the  or  key until [Hexdump] is displayed.
. . .		
[Hexdump] ↓ 	The Hexdump Mode is activated.
[Hexdump] ↓	
[Online] 	The printer is turned ON LINE again.

Note: By activating the normal print mode (see next page) or by turning the printer off and on again the printer can be taken out of Hexdump Mode. Time between turning the printer off and on again should be at least 15 seconds.

5.5. Normal Print Mode Activation (incl. FORM FEED)

The normal print mode suspends the Hexdump Mode. This function is activated, when a print job must be continued without turning the printer off and on again.







In addition to that the function "Normal Print Mode Activation" is used to produce a FORM FEED.

<u>Panel display</u>			<u>Notes</u>
[Online]		Turn the printer OFF LINE with this key.
		↓	
[Menu Level 1]		Press this key. Menu Level 1 is selected.
		↓	
[Status Sheet]		Press the  or  key until [Normal Print/FF] is displayed.
...		↓	
[Normal Print/FF]			The normal print mode is activated.
		↓	
[Normal Print/FF]			The printer is turned ON LINE again.
[Online]		

Note: After activating the normal print mode a FORM FEED is released automatically and one sheet is put out. This is necessary because after a test in the Hexdump Mode it is possible that data can remain in the input buffer unintentionally. (Cause: in the Hexdump Mode no control characters are evaluated and no FORM FEED is effected).

5.6. Clearing the Input Buffer (Cancel Job)







This function permits the resumption of a print job at a particular page after a print interruption (e.g. paper jam). The data contained in the input buffer before the interruption are cleared.

<u>Panel display</u>		<u>Notes</u>
[Online]	 Turn the printer OFF LINE with this key.
[Menu Level 1]	↓  Press this key. Menu Level 1 is selected.
[Status Sheet]	↓
. . .		 Press the  or  key until [Cancel Job] is displayed.
[Cancel Job]	↓  All data contained in the input buffer will be cleared.
[Cancel Job]	↓
[Online]	 The printer is turned ON LINE again.

5.7. Printing the Menu Page

This function prints a survey of the available panel functions.









Note: When printing the menu page please use a large paper.

<u>Panel display</u>			<u>Notes</u>
[Online]		Turn the printer OFF LINE with this key.
[Menu Level 1]	↓	
			Press this key. This selects Menu Level 1.
[Status Sheet]	↓	
. . .			Press the  or  key until [Menu Page] is displayed.
[Menu Page]	↓	
			A menu structure presentation of the printer is printed (compare diagram in section Menu Structur).
[Menu Page]	↓	
			The printer is turned ON LINE again.
[Online]		

5.8. Generating Testsheets (Sliding Pattern)

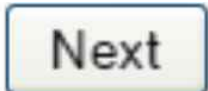
This function generates a series of test prints without sending data to the printer.

These test prints facilitate error analysis.

<u>Panel display</u>			<u>Notes</u>
[Online]			Turn the printer OFF LINE with this key.
[Menu Level 1]		↓	
			Press the  or  key until [Page Menu] is displayed.
[Status Sheet]		↓	
...			Press the  or  key until [Sliding Pattern] is displayed.
[Sliding Pattern]		↓	
			A series of test prints is generated.
[Sliding Pattern]		↓	
[Online]			The printer is turned ON LINE again .

















The printing out of test prints can be stopped by pressing the  key.

5.9. Feeder Selection (Tray)

This function enables the user to choose a particular feeder (cassette).

Note: If Size Sensing (see section Format Check) is enabled, the current paper size has priority. (See section Paper Size Selection).

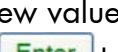
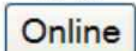















<u>Panel display</u>	<u>Notes</u>
[Online] 1	 Turn the printer OFF LINE with this key.
[Menu Level 1] 1	↓
...	 Press the  or  key until [Paper Menu] is displayed.
[Paper Menu] 1	↓
	 Press this key. This selects the Paper Menu.
[Output Face] 1	↓
...	 Press the  or  key until [Feeder Select] is displayed.
[Feeder Select] 1	↓
	 Press this key. This selects the Feeder Select menu.
[Feeder 1] 1	↓
...	 Press the  or  key until the desired feeder is displayed.
[Feeder 2] 1	↓
	 Feeder 2 (Cassette 2) is selected.
[Save as Setup?] 1	  In addition this new value can be saved as setup value (using the  key), before the printer is turned ON LINE again.
	
[Online] 1	

Feeder assignment:

Manual Feed	Manual Feeder (optional, MX-MFX1 e.g.)
Feeder 1	first paper tray (upper left)
Feeder 2	second paper tray (upper right)
Feeder 3	third paper tray (below tray 1 + 2)
Feeder 4	fourth paper tray (bottom)
...	
Auto. 1+2	Automatic selection between feeders (the subset of feeders is settable, tray 1+2 = default)
Auto.Sel. Mode	Automatic selection between all feeders that are installed (Feeder Linking)

5.10. Stacker Selection

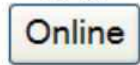
This function enables the user to choose a particular stacker.

Panel display		Notes
[Online	1	 Turn the printer OFF LINE with this key.
[Menu Level 1	1	↓
. . .		 Press the  or  key until [Paper Menu] is displayed.
[Paper Menu	1	↓
		 Press this key. The Paper Menu is selected.
[Output Face	1	↓
. . .		 Press the  or  key until [Stacker Select] is displayed.
[Stacker Select	1	↓
		 Press this key. The Stacker Select Menu is selected.
[Paper Tray 1	1	↓
. . .		 Paper Tray 1 = Current default. Press the  or  key until the selected Paper Tray (e.g. Paper Tray 2) is displayed.
[Paper Tray 2	1	↓
		 Paper Tray 2 is selected.
[Save as Setup?	1	↙ ↘  
[Online	1	↙ ↘  In addition this new value can be saved as setup value (using the  key), before the printer is turned ON LINE again.

Output Bin (Tray) assignment:Example: **Finisher MX-FN24** (Option)

Paper Tray 1 top output bin of the finisher

Paper Tray 2 offset output bin of the finisher

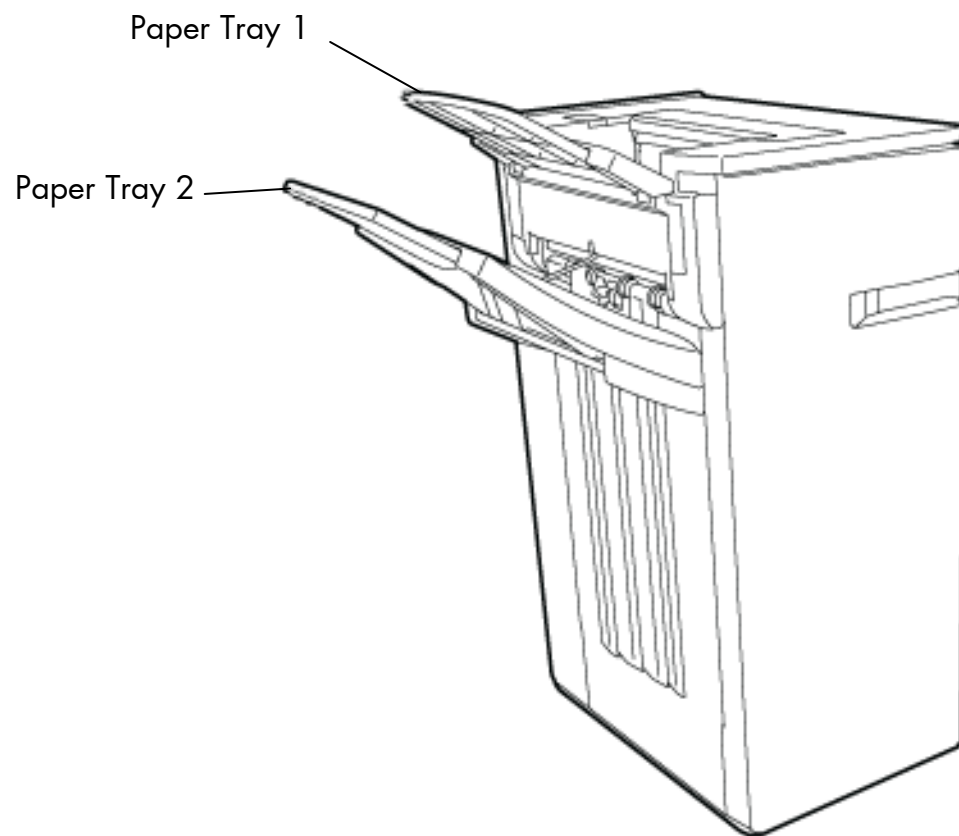















Fig. 5.10.a Finisher MX-FN24 (optional output device with staple function and offset function)















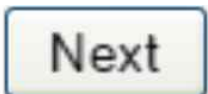

5.11. Output Face Selection (Face Up or Face Down)

This panel function serves to select the pages are output **Face Up** (the printed side of the page points up) or **Face Down**.

<u>Panel display</u>		<u>Notes</u>
[Online	1	
		Turn the printer OFF LINE with this key.
[Menu Level 1	1	↓
. . .		
		Press the  or  key until [Paper Menu] is displayed.
[Paper Menu	1	↓
		
		Press this key. The Paper Menu is selected.
[Output Face	1	↓
		
		Press this key. The Output Face Menu is selected.
[Face Down	1	↓
. . .		
		Press the  or  key until the desired Output Face is displayed.
[Face Up	1	↓
		
		The printed side of the page points up (Face Up).
[Save as Setup?	1	 
		In addition this new value can be saved as setup value (using the  key), before the printer is turned ON LINE again.
[Online	1	

5.12. Print Mode Selection (Simplex/Duplex)

The prerequisite for this function is that the print system is equipped with a duplex unit. This panel function allows the user to choose between simplex and duplex. (Simplex = one-sided printing, Duplex = double-sided printing).

<u>Panel display</u>			<u>Notes</u>
[Online]		Turn the printer OFF LINE with this key.
[Menu Level 1]	↓	
...			Press the  or  key until [Page Menu] is displayed.
[Page Menu]	↓	
			Press this key. The Page Menu is selected.
[Output Face]	↓	
...			Press the  or  key until [Simpl./Dupl.] is displayed.
[Simpl./Dupl.]	↓	
			Press this key. The Simpl.Dupl. menu is selected.
[Simplex]	↓	Simplex = currently set value.
...			Press the  or  key until the desired print mode is displayed.
[Duplex Mode 5]	↓	
			The duplex mode 5 is selected.
[Save as Setup?]	 	In addition this new value can be saved as setup value (using the  key), before the printer is turned ON LINE again.
[Online]		

Information about the Print Mode command:



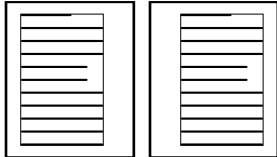
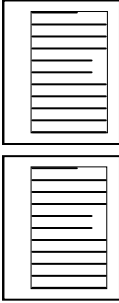
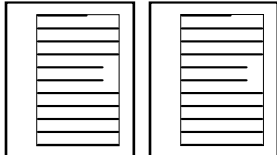













This command switches „intelligent“ printing on the front and rear side of a page on and off.

Duplex Mode	Description
0	Switches duplex print mode off
1	Duplex print mode long format-side, with rear side displacement *)
	
2	Duplex print mode short format-side, without rear side displacement
	
3	Duplex print mode long format-side, without rear side displacement for preprinted paper
4	Duplex print mode short format-side, without rear side displacement for preprinted paper
5	Duplex print mode long format-side, without rear side displacement
	

*) Rear side displacement is presently not realized, for this reason the result is the same as using mode 5





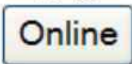









5.13. Paper Size Selection

This function selects the size of the print page (print image). (This setting has priority over the tray selection, compare section Feeder Selection).

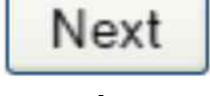
<u>Panel display</u>			<u>Notes</u>
[Online]		Turn the printer OFF LINE with this key.
[Menu Level 1]	↓	
. . .			Press the  or  key until [Paper Menu] is displayed.
[Paper Menu]	↓	
			Press this key. The Paper Menu is selected.
[Output Face]	↓	
. . .			Press the  or  key until [Paper Size] is displayed.
[Paper Size]	↓	
			Press this key. The Paper Size menu is selected.
[Letter]	↓	Letter = currently adjusted default.
. . .			Press the  or  key until the selected paper size (e.g. Legal) is displayed.
[Legal]	↓	
			The paper size Legal is selected.
[Save as Setup?]	 	In addition this new value can be saved as setup value (using the  key), before the printer is turned ON LINE again.
[Online]		

5.14. Print Direction Selection













This function selects the active print orientation (orientation of the whole printout including graphics, etc. on the paper).

<u>Panel display</u>	<u>Notes</u>
[Online]	 Turn the printer OFF LINE with this key.
[Menu Level 1]	↓
...	 Press the  or  key until [Paper Menu] is displayed.
[Paper Menu]	↓
	 Press this key. The Paper Menu is selected.
[Output Face]	↓
...	 Press the  or  key until [Print Direct.] is displayed.
[Print Direct.]	↓
	 Press this key. The Print Direction menu is selected.
[Print Direct. 0]	↓
...	 Press the  or  key until the desired print direction is displayed.
[Print Direct. 1]	↓
	 The print direction 1 = landscape is selected.
[Save as Setup?]	 In addition this new value can be saved as setup value (using the  key), before the printer is turned ON LINE again.
	
[Online]	

Print direction assignment: Print direction 0 = Portrait (upright format)
 Print direction 1 = Landscape (horizontal format)
 Print direction 2 = Portrait upside down
 Print direction 3 = Landscape upside down

5.15. Data Interface Configuration

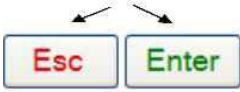

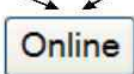













This function is used to set the interface parameters.

<u>Panel display</u>	<u>Notes</u>
[Online]	
	
	Turn the printer OFF LINE with this key.
[Menu Level 1]	↓
. . .	
	Press the  or  key until [Configuration] is displayed.
[Configuration]	↓
	
	Press this key. This selects the Configuration menu.
[Interface]	↓
	
	Press this key. This selects the Interface menu.
[SIA Timeout]	↓
	
	Press this key. This selects the Timeout menu.
[30 s]	↓
	The currently set value for the timeout is displayed (here: 30 seconds).
. . .	
	Pressing the  or  key changes the timeout value. .
[40 s]	↓
	
	The timeout (the waiting period for SIA to switch to the next interface) is increased to 40 seconds.
[Save as Setup?]	
	In addition this new value can be saved as setup value (using the  key), before the printer is turned ON LINE again.
[Online]	

Note: The printer uses SIA (Simultaneous Interface Administration) to check, which interface is currently used for the transfer of print data.

5.16. Emulation Selection

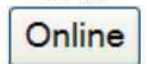
This function helps to determine which printer emulation will be activated.

<u>Panel display</u>	<u>Notes</u>
[Online] 1	 Turn the printer OFF LINE with this key.
[Menu Level 1] 1	↓
. . .	 Press the  or  key until [Configuration] is displayed.
[Configuration] 1	↓
	 Press this key. This selects the Configuration menu.
[Interface] 1	↓
. . .	 Press the  or  key until [Emulation] is displayed.
[Emulation] 1	↓
	 Press this key. This selects the Emulation menu.
[SOLID Standard] 1	↓
. . .	 Press the  or  key until the desired emulation (e.g. HP PCL 5) is displayed.
[HP PCL 5] 1	↓
	 The emulation HP PCL 5 is selected.
[Save as Setup?] 1	↙ ↘
	 
[Online] 1	↙ ↘
	 In addition this new value can be saved as setup value (using the  key), before the printer is turned ON LINE again.

Available emulations:

Standard:

MICROPLEX IDOL,
HP LaserJet (PCL 5),
Epson FX,
IBM Proprinter,
TIFF (CCITT group 4)

Optional:

μPostscript,
Kyocera Prescribe,
Printronix IGP/PGL,
Diablo 630,
AGFA Reno,
S3000 Lineprinter,
HPGL (7475A),
DEC LN03+,
Tally MT 6xx,
Bull MP6090,
TEC B6xx (Thermal Transfer),
TEC Bx72 (Thermal Transfer),
Etimark (Thermal Transfer),
IDS/IDS2,
Datamax (FGL),
Eltron EPL2,
QMS (Magnum) Code V,
ANSI (Genicom),
XEROX XES,
HP DesignJet (HPGL-2),
LDC (Label Description Language),
Express,
ZPL II (Zebra Programming Language)

Notice:

The brand names mentioned are registered trademarks of the enterprises named above.





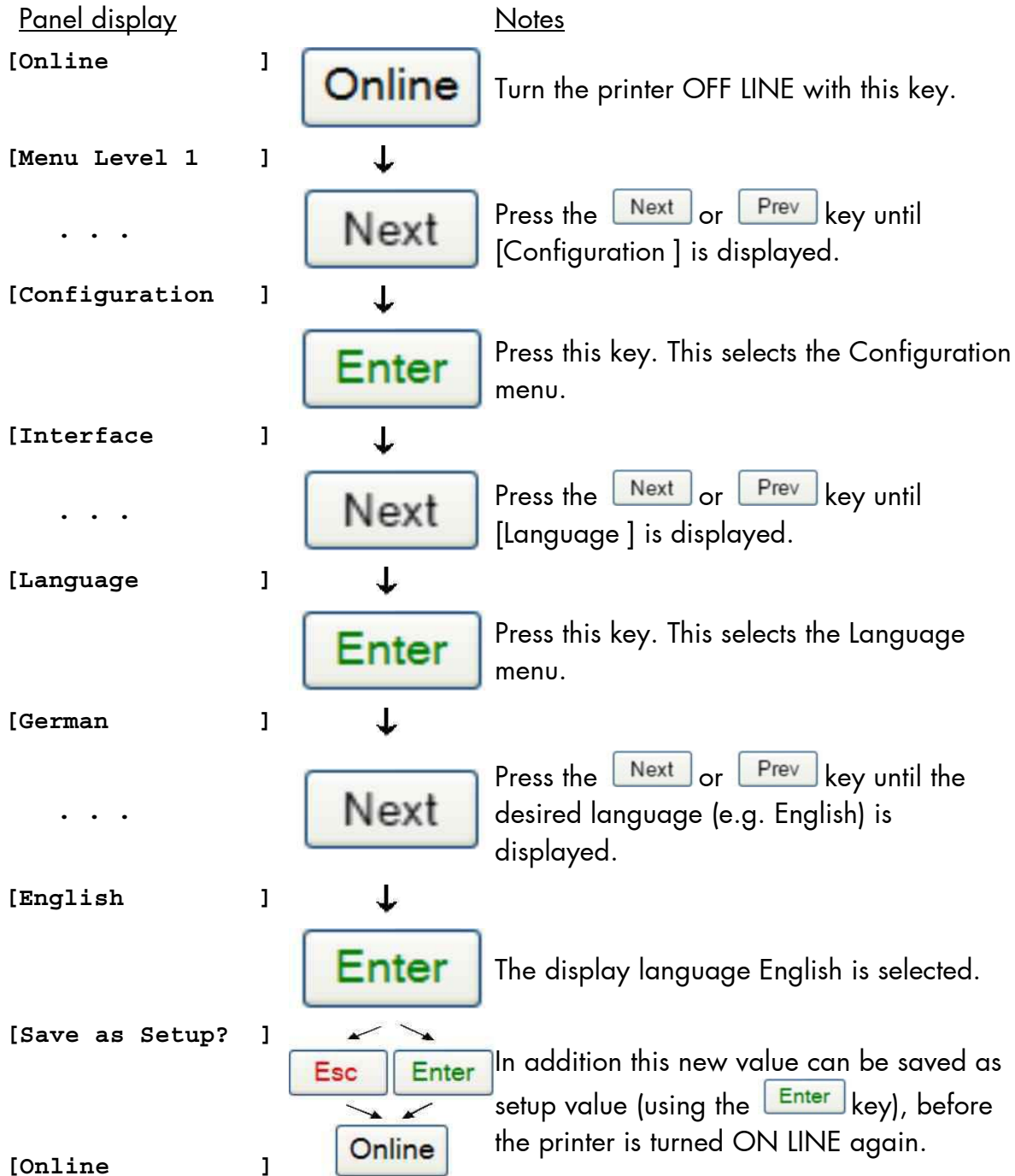











5.17. Display Language Selection

This function enables the user to determine the language for the display messages, the status sheet and the font list.







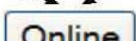







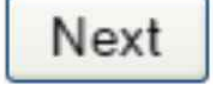

5.18. Transparent Code Adjustment

This function configures the transparent code. Using the transparent code enables you to initiate the commands of the page description language IDOL by **printable** characters. The transparent code pre-setting is 2625. These are the ASCII character codes (hexadecimal) for the characters &% (ref. IDOL Programming Manual).

<u>Panel display</u>	<u>Notes</u>
[Online]	 Turn the printer OFF LINE with this key.
[Menu Level 1]	↓
...	 Press the  or  key until [Configuration] is displayed.
[Configuration]	↓
	 Press this key. The Configuration menu is selected.
[Interface]	↓
...	 Press the  or  key until [Transparent Code] is displayed.
[Transparent Code]	↓
	 Press this key. The Transparent Code menu is selected.
[Digit4 2625]	↓
...	The hexadecimal number for & % is preset. Pressing the  or  key changes the value of the current digit. (Digit 4 = left position, in this example: 2). Pressing the  key moves you to the next digit (the  key moves you back, if need be).
	↓
[Digit1 2626]	 2626 is selected as transparent code. From now on use the characters & & before programming the IDOL commands.
[Save as Setup?]	  In addition this new value can be saved as setup value (using the  key), before the printer is
[Online]	 turned ON LINE again.





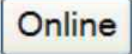





5.19. Selection of Memory Distribution (Input Buffer)

This function enables the user to choose the distribution of the available RAM memory between input buffer and macro/download memory.

<u>Panel display</u>	<u>Notes</u>
[Online] 1	 Turn the printer OFF LINE with this key.
[Menu Level 1] 1	↓
. . .	 Press the  or  key until [Configuration] is displayed.
[Configuration] 1	↓
	 Press this key. This selects the Configuration menu.
[Interface] 1	↓
. . .	 Press the  or  key until [Input Buffer] is displayed.
[Input Buffer] 1	↓
	 Press this key. This selects the Input Buffer menu.
[32 kB] 1	↓
. . .	 Press the  or  key until the desired memory distribution is displayed. The input buffer size is specified in kilobyte (kB) or in percent of the installed memory.
[100 kB] 1	↓
	 100 kB is selected as input buffer.
[Save as Setup?] 1	  In addition this new value can be saved as setup value (using the  key), before the printer is turned ON LINE again.
[Online] 1	



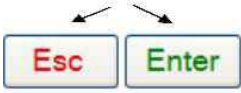

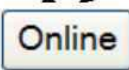







5.20. Setting to Factory Default

This function back-outs all configurations to factory defaults.

<u>Panel display</u>	<u>Notes</u>
[Online]	 Turn the printer OFF LINE with this key.
[Menu Level 1]	↓
. . .	 Press the  or  key until [Configuration] is displayed.
[Configuration]	↓
	 Press this key. This selects the Configuration menu.
[Interface]	↓
. . .	 Press the  or  key until [Factory Default] is displayed.
[Factory Default]	↓
	 Press this key.
[Save as Setup?]	 Only if you press the  key a second time the configuration will be back-outed to factory defaults.
	
[Online]	The printer is turned ON LINE again.

5.21. Font Selection

This function selects the active font. Select a font number out of the list of available fonts.

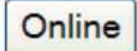
<u>Panel display</u>			<u>Notes</u>
[Online]		Turn the printer OFF LINE with this key.
[Menu Level 1]	↓	
. . .			Press the  or  key until [Page Menu] is displayed.
[Page Menu]	↓	
			Press this key. This selects the Page Menu.
[Font Number]	↓	
			Press this key. This selects the Font menu.
[Font 0600]	↓	
. . .			Press the  or  key until the desired font number (5507 Langeoog e.g.) is displayed.
[Font 5507]	↓	
			The font number 5507 Langeoog is selected.
[Save as Setup?]	 	In addition this new value can be saved as setup value (using the  key), before the printer is turned ON LINE again.
[Online]		

The **SOLID 90 A3, 105 A3 and 120 A3 standard equipment** contains the following **fonts**:

<u>Font no.</u>	<u>Font width</u>	<u>Font height</u>	<u>Font name</u>
0600	10	12	Kurilen
0602	10	12	Kurilen Italic
0610	12	10.1	Kurilen
1710	12	10.1	Kurilen Italic
4508	P	8.1	Helgoland
4510	P	10	Helgoland
4714	P	14.4	Helgoland Bold
5507	20	7	Langeoog
5508	16.6	7.9	Langeoog
5509	15	9.1	Langeoog
6610	10	10.1	Juist Monosp.
9210	P	10.1	Tasmanien
9310	P	10.1	Tasmanien Italic
2000	P	SC	Tasmanien
9900	P	SC	Neuwerk

Resumption of this standard font list see next page.

Explanations:

Font width:

Character distance in CPI (Characters Per Inch).

P = proportional, (meaning that each character has an individual width).

Font height:

Font height from the lowest descender to the upper edge of the highest character, measured in graphical points (1/72 inch).

SC = scalable.

















	<u>Font no.</u>	<u>Font width</u>	<u>Font height</u>	<u>Font name</u>
	0050	SC		Plakatschrift
	0590	SC		OCR /B
	0591	SC		OCR /A
	6600	SC		Juist Monospaced
PCL 5 compatible	0699	SC		Kurilen
	1700	SC		Kurilen Italic
	1800	SC		Kurilen Bold
	1900	SC		Kurilen Bold Italic
	5500	SC		Langeoog
	5600	SC		Langeoog Bold
	5700	SC		Langeoog Italic
	5800	SC		Langeoog Bold Italic
	2100	P	SC	Texel Bold
	2200	P	SC	Texel Italic
	2300	P	SC	Texel Bold Italic
	9800	P	SC	Neuwerk Italic
	9500	P	SC	Neuwerk Bold Italic
	9600	P	SC	Neuwerk Bold
	0060	SC		Plakatschrift
	9501	P	SC	Neuwerk-II Condensed Italic
	9601	P	SC	Neuwerk-II Condensed Bold Ital.
	9801	P	SC	Neuwerk-II Condensed Bold
	9901	P	SC	Neuwerk-II Condensed
	0530	P	SC	PiktoWin
	5100	P	SC	Amrum
	5200	P	SC	Amrum Bold
	5300	P	SC	Amrum Italic
	7500	P	SC	Antigua
	7700	P	SC	Antigua Bold
	7800	P	SC	Antigua Italic
	7900	P	SC	Antigua Bold Italic
9199	P	SC	Tasmanien-II Bold Italic	
9299	P	SC	Tasmanien-II	
9399	P	SC	Tasmanien-II Italic	
9499	P	SC	Tasmanien-II Bold	

Notes: Additional fonts can be selected from the font catalogue depending upon the memory capacity.

You can use the panel function Printing the Font List (see section 5.2) to generate a list of all fonts installed to the printer.

5.22. Text Orientation Selection

This function selects the active text orientation.

<u>Panel display</u>	<u>Notes</u>
[Online]	 Turn the printer OFF LINE with this key.
[Menu Level 1]	↓
. . .	 Press the  or  key until [Page Menu] is displayed.
[Page Menu]	↓
	 Press this key. The Page Menu is selected.
[Font Number]	↓
. . .	 Press the  or  key until [Orientation] is displayed.
[Orientation]	↓
	 Press this key. The Orientation menu is selected.
[Orientation 0]	↓
. . .	 Press the  or  key until the desired text direction is displayed.
[Orientation 1]	↓
	 The orientation 1 = landscape is selected.
[Save as Setup?]	↙ ↘
	  In addition this new value can be saved as setup value (using the  key), before the printer is turned ON LINE again.
[Online]	

Text orientation assignment:

- Orientation 0 = Portrait (upright format)
- Orientation 1 = Landscape (horizontal format)
- Orientation 2 = Portrait upside down
- Orientation 3 = Landscape upside down





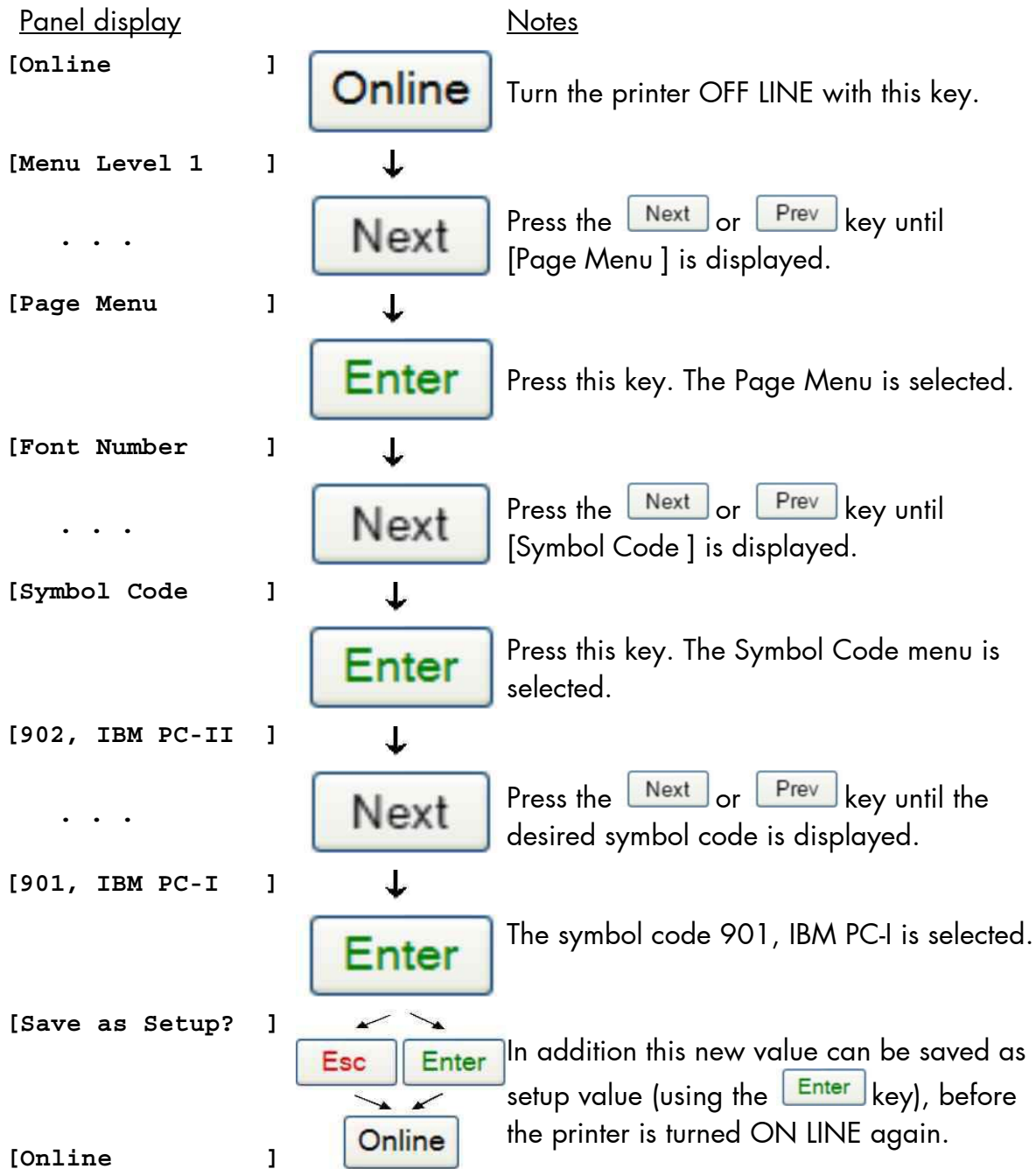









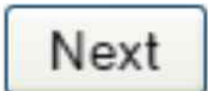

5.23. Symbol Code Selection

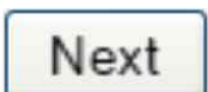
This function selects the active symbol code.

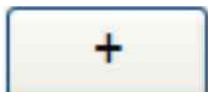

5.24. Configuration of Text Margins

This function sets text margins. Margins are expressed in dots at the concerning edge of the paper.

Panel display		Notes
[Online] 	Turn the printer OFF LINE with this key.
[Menu Level 1] ↓	
...		Press the  or  key until [Page Menu] is displayed.
[Page Menu] ↓	
		Betätigen Sie diese Taste, dadurch wird das Konfigurationsmenü gewählt.
[Font Number] ↓	
...		Press the  or  key until [Margin] is displayed.
[Margin] ↓	
		Press this key. This selects the Margin configuration menu.
[Left] ↓	
...		Press the  or  key until the desired margin is displayed.
[from Right] ↓	
		Press this key if you want to configure the right margin.
[Digit4	0081] ↓	The currently set value is displayed.
...		Pressing the  or  key changes the value of the current digit. (Digit 4 = left position, in this example: 0). Pressing the  key moves you to the next position (the  key moves you back, if need be).

[Digit1 0087]



The right margin is changed to 87 dot.

[Save as Setup?]

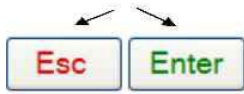















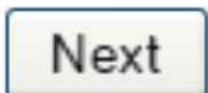

In addition this new value can be saved as setup value (using the  key), before the printer is turned ON LINE again.

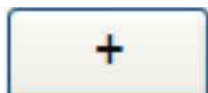
[Online]







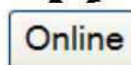













5.25. Lines per Inch Setting (Line Spacing)

This function sets the number of lines per inch. This setting is effective only in case of using the printer as a line printer. With a small number of lines per inch, line spacing will be relatively large. (Ref. IDOL Programming Manual).

<u>Panel display</u>	<u>Notes</u>
[Online] 1	
	
	Turn the printer OFF LINE with this key.
[Menu Level 1] 1	↓
. . .	
	Press the  or  key until [Page Menu] is displayed.
[Page Menu] 1	↓
	
	Press this key. This selects the Page Menu.
[Font Number] 1	↓
. . .	
	Press the  or  key until [Line Spacing] is displayed.
[Line Spacing] 1	↓
	
	Press this key. This selects the Line Spacing configuration menu.
[Digit4 006.5] 1	↓
. . .	
	6.5 lpi = currently set value. (lines per inch). Pressing the  or  key changes the value of the current digit. (Digit 4 = left position, in this example: 0). Pressing the  key moves you to the next digit (the  key moves you back, if need be).
[Digit1 010.0] 1	↓
	
	The number of lines per inch was increased to 10 lpi.
[Save as Setup?] 1	↙ ↘
	 
	In addition this new value can be saved as setup value (using the  key), before the printer is turned ON LINE again.
[Online] 1	↓
	

5.26. Number of Characters per Inch Setting (Character Spacing)















This function sets the number of characters per inch. This setting is effective only in case of using a line printer emulation. With a small number of characters per inch, character spacing will be relatively large. (Ref. IDOL Programming Manual).

Panel display		Notes
[Online	1	
		Turn the printer OFF LINE with this key.
[Menu Level 1	1	↓
...		
		Press the  or  key until [Page Menu] is displayed.
[Page Menu	1	↓
		
		Press this key. This selects the Page Menu.
[Font Number	1	↓
...		
		Press the  or  key until [Char. Spacing] is displayed.
[Char. Spacing	1	↓
		
		Press this key. This selects the configuration menu.
[Digit4 013.3]	1	↓
		13.3 cpi = currently set value. (characters per inch).
...		
		Pressing the  or  key changes the value of the current digit. (Digit 4 = left position, in this example: 0). Pressing the  key moves you to the next digit (the  key moves you back, if need be).
[Digit1 012.0]	1	↓
		
		The number of characters per inch was reduced to 12 cpi.
[Save as Setup?	1	↙ ↘
		 
		In addition this new value can be saved as setup value (using the  key), before the printer is
[Online	1	↙ ↘
		
		turned ON LINE again.

5.27. Configuration of Network Parameters (IP Address, e.g.)

The functions of the submenu Network are used to set the parameters for connecting the printer to a network (Ethernet).

Setting the IP address manually:



Panel display		Notes
[Online] 	Turn the printer OFF LINE with this key.
[Menu Level 1] ↓	
. . .		Press the  or  key until [Page Menu] is displayed.
[Network] ↓	
		Press this key. The Network menu is selected.
[Timeout] ↓	
. . .		Press the  or  key until [Ethernet] is displayed.
[Ethernet] ↓	
		Press this key. The Ethernet menu is selected.
[IP Assign] ↓	
		Press this key. The IP Assign menu is selected.
[Off] ↓	The current configuration is displayed.
. . .		Press the  or  key until [Manual] is displayed.
[Manual] ↓	
		Press this key to change address assignments, manually.
[IP Address] ↓	
		Press this key to set the IP address manually.

[192.168.002.002]





The current IP Address is displayed.



Pressing the  or  key changes the value of the current digit. (Left digit first, in this example: 1).

. . .

Pressing the  key moves you to the next digit (the  key moves you back, if need be).

[192.168.010.123]



The new IP address is saved as setup value.



[Saved !]



The printer is turned ON LINE again.



Note:

The current network settings are shown on the Status Sheet of your printer, too.

Notes: If your network is using DHCP^①, an address can be automatically assigned (select the item **DHCP** from the network submenu IP Assign).

The parameters **Subnet Mask** and **Gateway** are configured in the same way as described above. Please select the concerning panel functions for this (compare section 4.8 Menu Structure).

Select the subitem **Off** from the network menu to switch off the network access.

^① Dynamic Host Configuration Protocol: offers among other things a centralized address management.

Duplex/Speed Setting

This panel function is located in the network menu (submenu Duplex/Speed Setting).

The factory default value is Autonegotiation.

Autonegotiation means that devices on the network agree a transmission mode, which each unit is able to handle, before data transmission starts. By this the printer automatically adjusts itself to maximize link performance.

Hint: Autonegotiation is the recommended setting!

If you set the Duplex/Speed parameters manually, you may experience problems. Wrong settings can slow down the speed of the link (worst case: communication does not occur).

Explanations:

Auto-Negotiation

A Ethernet procedure that allows devices at either end of a link segment to advertise and negotiate modes of operation such as the speed of the link (100 Mbit/s or 10 Mbit/s) and half- or full-duplex operation.

Half duplex

A device can either receive or send data at a given time.

Full duplex

Capability of a device for sending and receiving data at the same time. In the case of full duplex, collision detection is deactivated. A full duplex capable device is able to buffer data packets.

6. Operator Maintenance

In order to operate the printer on the highest quality level, it is necessary to carry out simple cleaning operations, and occasionally to replace special components.

These operations can be carried out by a MICROPLEX trained operator. A untrained person is not allowed to carry out these operations.



Please notice the status messages of the printer.
(See section 4.3 The Operation Panel of the Device.)

6.1. Printer Cleaning



For safety pull out the main plugs first. Make sure the elements that are to be cleaned have cooled down.

Please be especially careful to avoid damaging mechanical or electronical modules.

Do not use detergents, or any other devices or tools not mentioned in this manual to avoid damages and unnecessary costs of repairs.

6.1.1. Printer Cabinet Cleaning

Soilings like dust, grease or similar things can be removed with a soft, lint-free cloth. If necessary the cloth can be moistured with water or a neutral detergent. Inside the printer dust or paper dust can be removed best with a soft (non-metallic) brush.

6.1.2. Cleaning the Printer Interior



For safety pull out the power plugs of the device first. Make sure the elements that are to be cleaned have cooled down.

Please be especially careful to avoid damaging the mechanical or electronic modules.

Do not use detergents, or any other devices or tools not mentioned in this manual to avoid damages and unnecessary costs of repairs.

Use an antistatic service vacuum cleaner to remove any toner particles, paper dust, and so forth inside the device.

6.2. Replacing the Toner Cartridge



The message [Toner low] or [Toner supply is low] is only a warning that the printer will run out of toner soon. It is not necessary to replace the toner cartridge immediately.

Replace the toner cartridge with a new cartridge as soon as the message [Toner empty!] or [Change the toner cartridge] is displayed.

On average 120,000 pages of "A4" (for letter-size pages the amount is nearly the same) can be printed with one toner cartridge. (This depends on the print density. In this example, a print density of 6% was considered. The toner life may vary depending on temperature and humidity, too).



The toner cartridge can even be replaced while the machine is in operation.



Warning:

Only use consumables being specially developed for this device. Using unsuitable consumables may cause a reduction of output quality or damages.



Please store the print cartridge in its original packing until it is installed.

Always store toner cartridges on their side.
(If a toner cartridge is stored on end, the toner may harden and become unusable.)

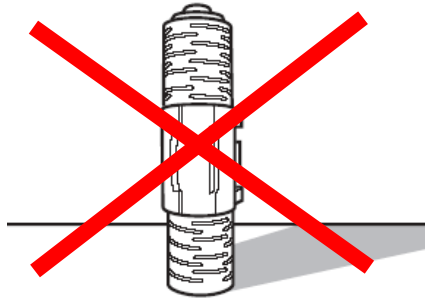

Fig. 6.2.a Do not store a toner cartridge on end



Extreme fluctuations of atmospheric humidity and/or temperature are not allowed.

The values listed in section 2.2 need to be met.

Please note: Do not shake or swing the toner cartridge.

Caution: Do not touch the toner fill hole. Always use the handle of the toner cartridge instead!

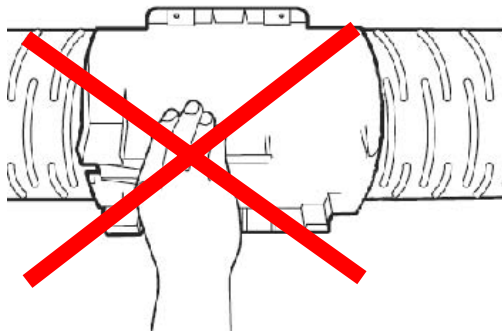

Fig. 6.2.b Do not touch this area, use the handle instead

In order to replace the print cartridge, follow these instructions:

1. Notice the information used with the print cartridge also.

a) Removing the old toner cartridge



Please wear vinyl gloves to avoid dirty hands when replacing the cartridge.

2. Slowly pull out the toner cartridge installation cover until it stops.

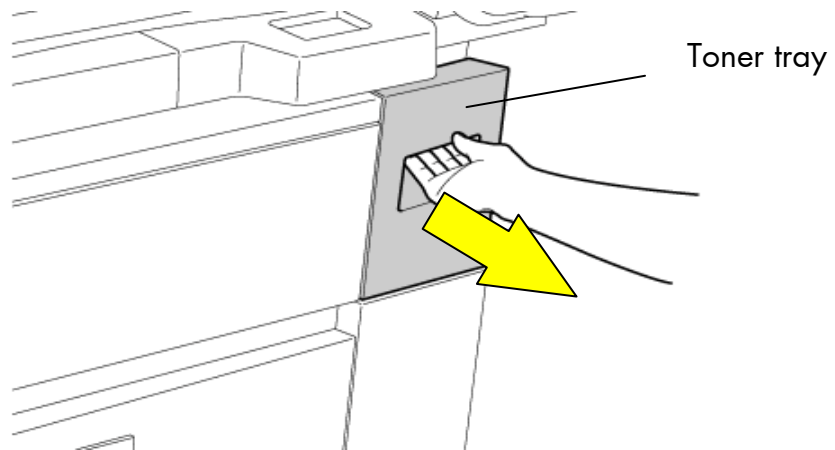

Fig. 6.2.c Opening the toner tray

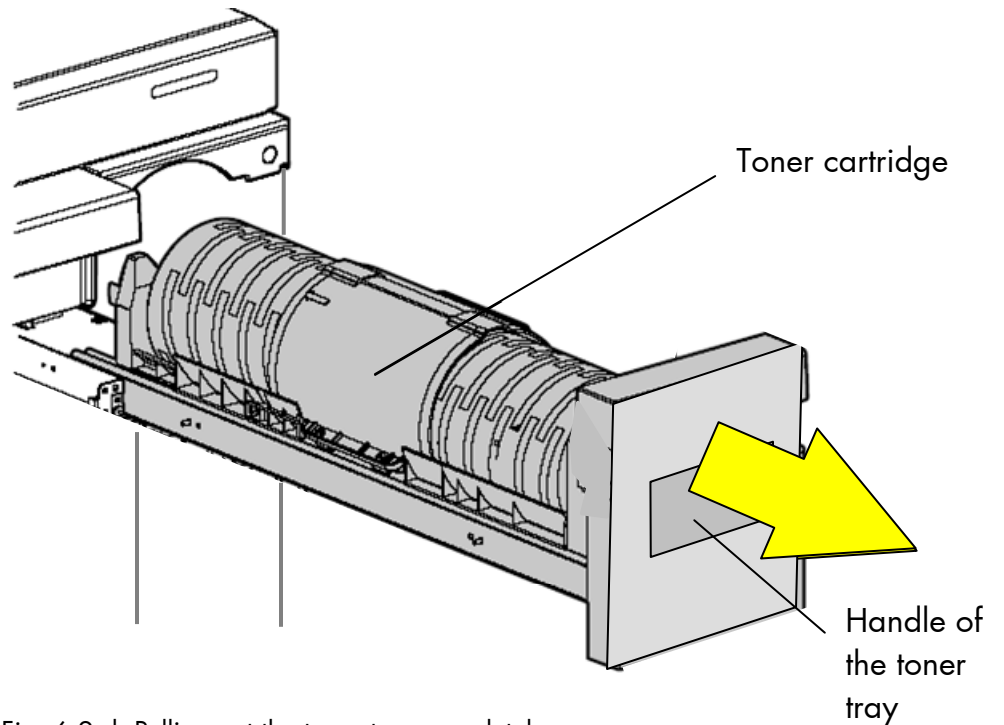

Fig. 6.2.d Pulling out the toner tray completely

3. Grasp the handle and slowly pull the old toner cartridge straight up and out. Place it on a suitable, flat surface.

Notice: If the toner cartridge is pulled out abruptly, toner may spill.

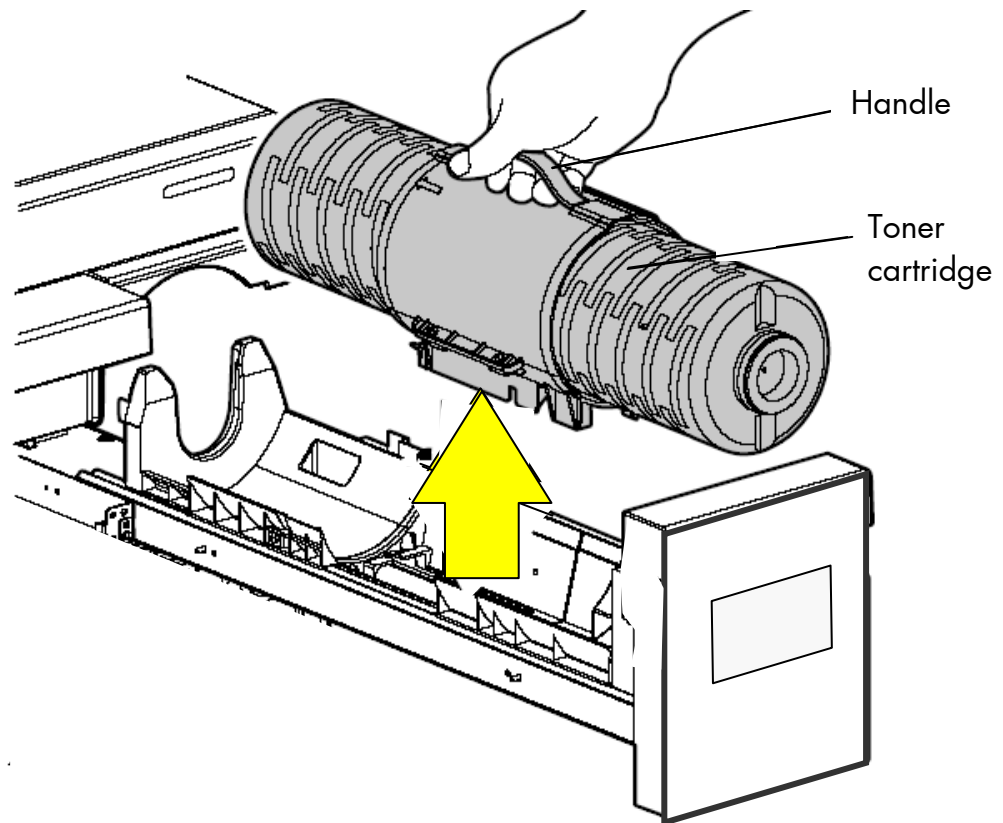

Fig. 6.2.e Taking the old toner cartridge out of the printer.

b) Cleaning the device

4. Use an antistatic service vacuum cleaner to remove any toner particles, paper dust, and so forth inside the device.

c) Inserting the new toner cartridge

5. Take the new toner cartridge out of the packing.
(Hint: please keep the packing.)
6. Put down the toner cartridge so the handle points upward.
7. Grasp the handle of the toner cartridge and hold the cartridge above the toner cartridge installation cover (as shown in the following figures).

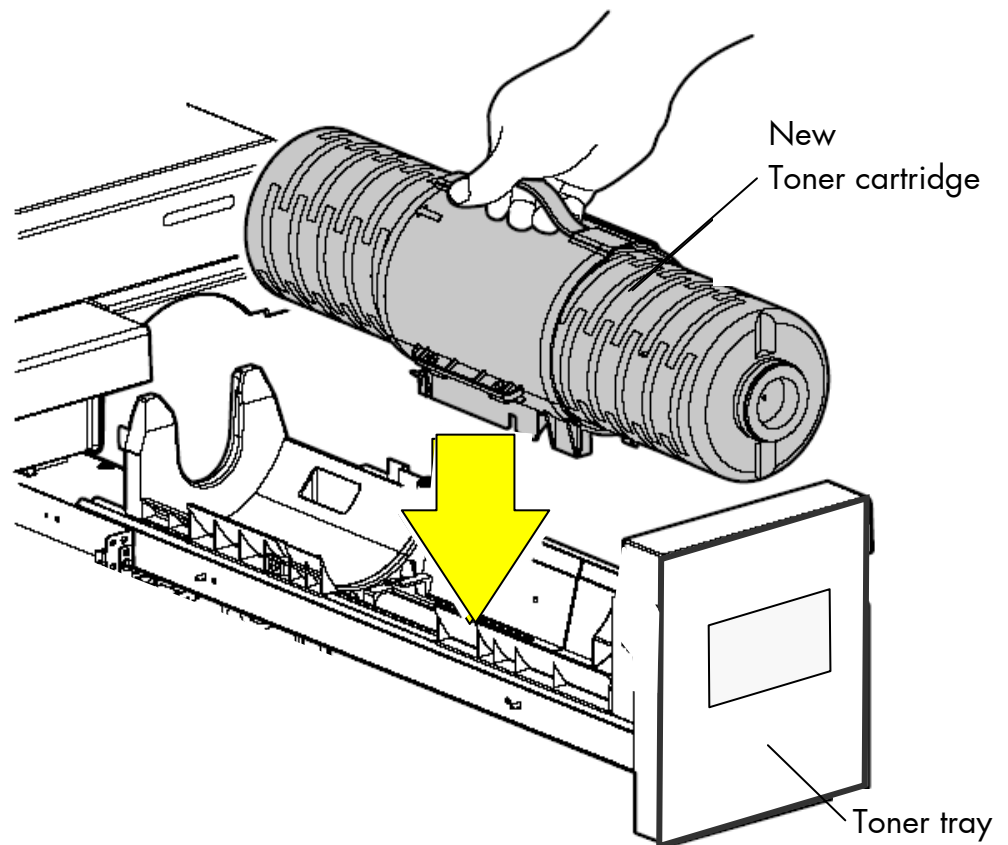

Fig. 6.2.f Inserting the new toner cartridge into the toner tray

8. Insert the new toner cartridge straight down into the guides of the device. (Both ends of the toner cartridge are equipped with a pivot, see the following figure).

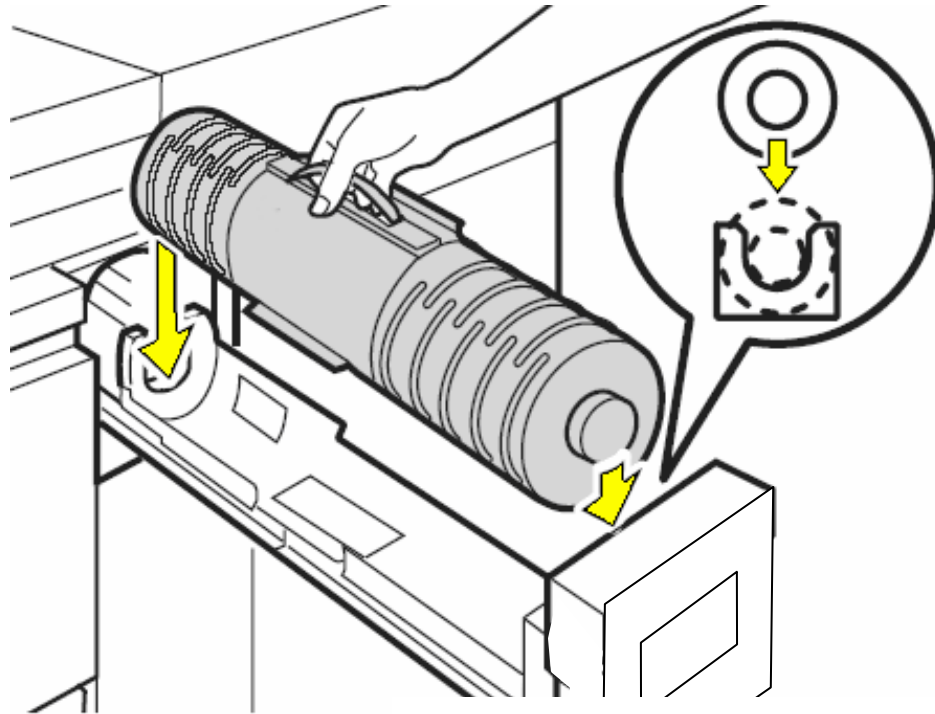

Fig. 6.2.g Detail: Inserting the toner cartridge into the guides

9. Slide the installation cover containing the new toner cartridge gently into the device until it locks into place.

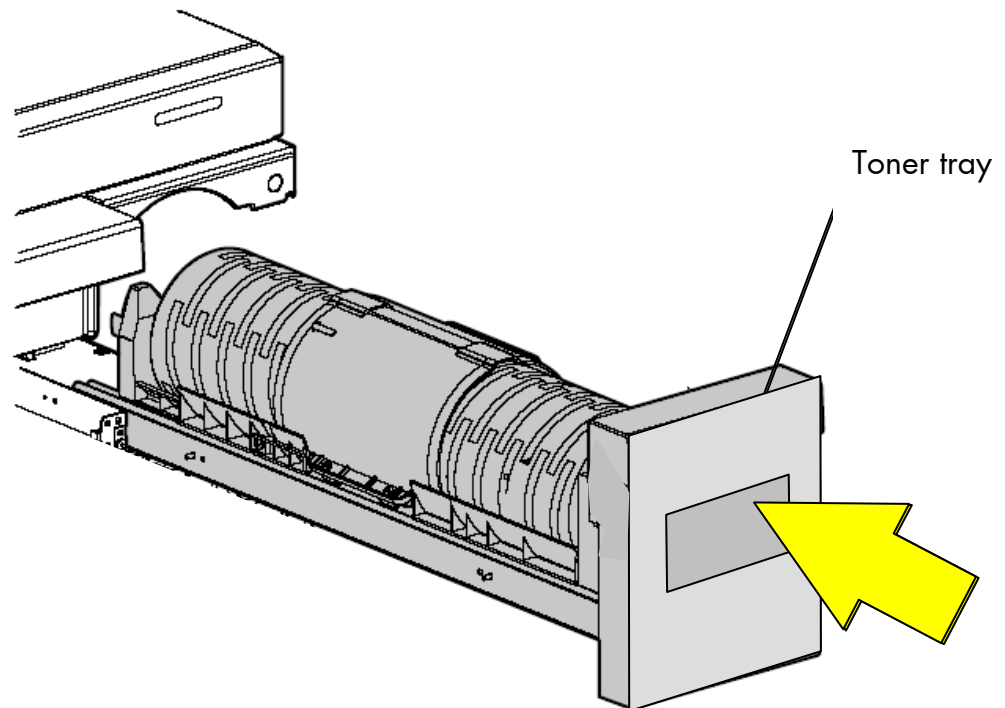

Fig. 6.2.h Sliding the new toner cartridge into the printer



Toner filling takes place automatically now performed by the device itself.

Do not open the toner cartridge installation cover until the message [Toner empty!] is displayed.

10. Place the used toner cartridge in the plastic bag you saved in step 5.

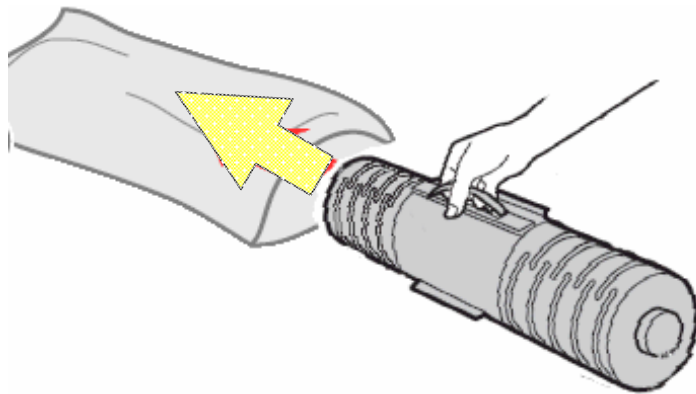

Fig. 6.2.i Use the plastic bag for the old toner cartridge



Please pay attention to the information about the disposal of the old toner cartridge (current information can be found on the new toner cartridge).



The toner is easily combustible and should never come in contact with fire.

Keep the old toner cartridge inside a closed cardboard box until the next service cycle date to give it to the service engineer. By returning the used toner cartridge, you help support world-wide recycling efforts.

11. Now replace the waste toner bottle, if required. (See next section.)

6.3. Replacing the Waste Toner Bottle (Toner Collection Container)



Replace the waste toner bottle immediately, if the message [Toner Waste !] is displayed.

On average 500,000 pages „A4“ can be printed until the waste toner bottle has to be exchanged.



Therefore the waste toner bottle should be replaced when the 500,000 pages maintenance is carried out by the service engineer.

In order to replace the waste toner bottle, follow these instructions:

1. Open the front cover of the device.

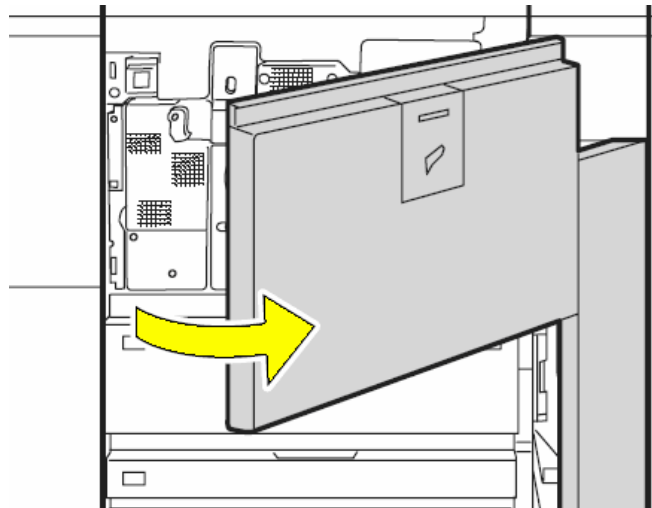

Fig. 6.3.a Opening the front cover of the device

The waste toner bottle may be heavy.



Use both hands to firmly support the bottle while removing it.

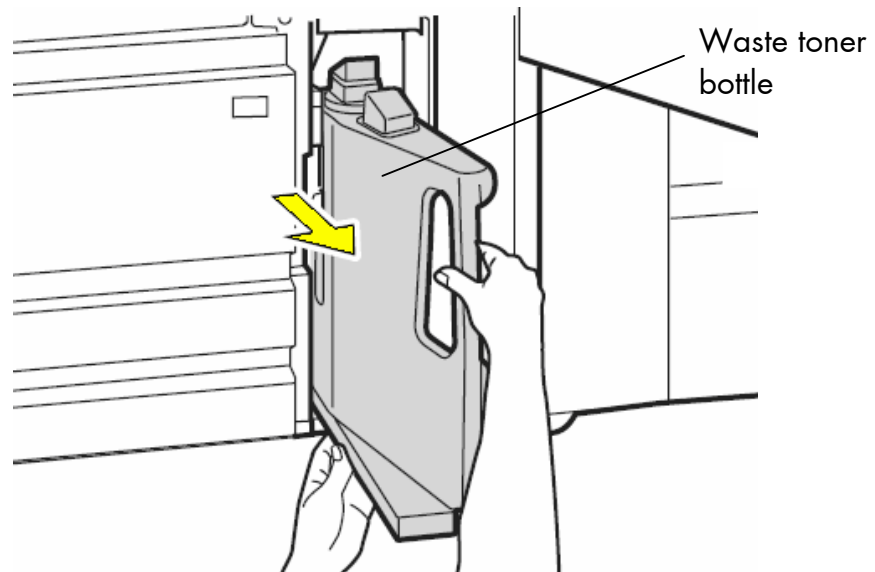

Fig. 6.3.b Removing the old waste toner bottle

2. Close the filled waste toner bottle using the cap located at the center of the waste toner bottle. (See the following figure.)

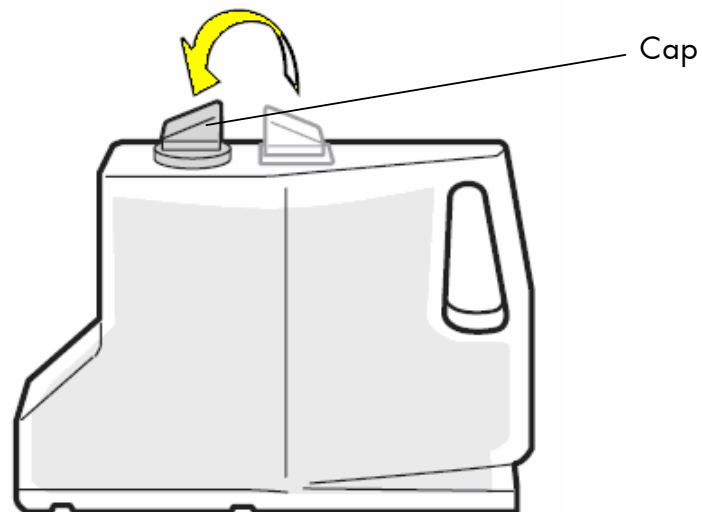

Fig. 6.3.c Use the cap to close the filled bottle

3. Remove all toner residues, paper dust etc. inside the device (in the opening for the waste toner bottle) using an anti-static service vacuum cleaner.
4. Take a new waste toner bottle and insert this bottle into the device.

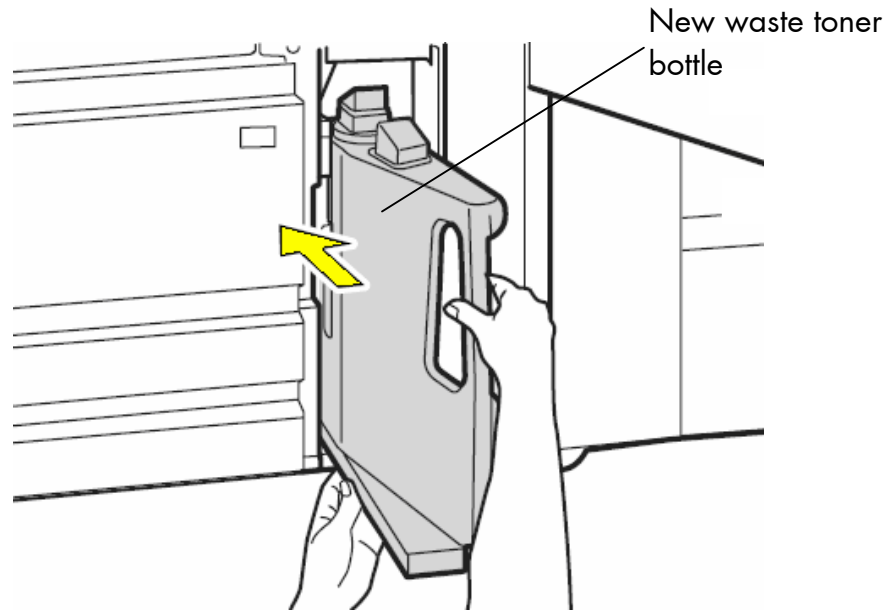

Fig. 6.3.d Inserting the new waste toner bottle

5. Close the front cover of the device.
Make sure the front cover is completely closed.

The announcement [Toner Waste !] will be extinguished.

6. Store the (used) waste toner bottle in a closed plastic bag.



The waste toner is easily combustible and should never come in contact with fire. Disposal will be carried out by your service engineer.

7. Troubleshooting



When an error occurs, a corresponding error message is displayed in the control panel of the printer (see section 7.3).

Please take notice of section 4.3 The Operation Panel of the Device, too.

Please address the problems described in this chapter yourself (especially the consumable replacement).

Please regard the following steps if a printer opening becomes necessary:



- During operation, components in the printer's interior will heat up. Make sure you do not burn your hands when you fix a paper jam.

- After closing the device, make sure all covers are firmly shut.



Only a MICROPLEX authorized operator or service engineer should address printer problems for which no remedies are given in the following pages.

When reporting a problem to your service engineer, please give him the precise error message so that he can more quickly localize the error.



If an error message indicates a paper jam, a print repeat will be necessary.

The printer is provided with an automatic jam safety function to prevent a loss of data.

This function can be switched off if the user wants to resume the print job at a position he chooses himself (see section 5.6 Clearing the Input Buffer).

7.1. Error in the Print Process

<u>Defect</u>	<u>Remedies</u>
Printer does not work	<p>- Check the power supply, switch on the device.</p> <p>If your device is not responding, first make sure:</p> <ul style="list-style-type: none">• The power cord is plugged into the device and a properly grounded electrical outlet.• The electrical outlet is not turned off by any switch or breaker.• Other electrical equipment plugged into the outlet is working.• The device is turned on.• The printer cable is securely attached to the device and the host computer, print server, option, or other network device. <p>Once you've checked each of these possibilities, turn the device off and back on. This often fixes the problem.</p> <p>- Make sure all covers of the device (e.g. front cover) are completely closed.</p> <p>- Read any error messages in the control panel (see section 7.3).</p> <p>- Refill paper feeders with paper of suitable size (see chapter 3).</p>
Repeated paper jam	<p>- After any paper jam, make sure all the jammed paper has been removed completely from the paper paths.</p> <p>- Carefully read the information in section 7.4: Print Media Jam.</p>

If the remedies above are not successful please switch off the device and contact a MICROPLEX authorized service engineer.

7.2. Reduced Print Quality

<u>Defect</u>	<u>Remedies</u>
Printout too light	<ul style="list-style-type: none"> - If the message [Toner Low] or the message [Toner empty !] is displayed, replace the toner cartridge (see section 6.2: Replacing the Toner Cartridge). - Do not use damp paper. - If you must print on special paper, please consider finding the most appropriate paper type. - Check the environmental conditions and change them if necessary. Make sure you know the admissible values for relative humidity, temperature etc.. See also section 2.2: Printer Installation.
Toner residues on the back side of the printouts	<ul style="list-style-type: none"> - Clean the device

If the remedies above are not successful, please contact a MICROPLEX authorized service engineer.

7.3. Error Messages

If an error occurs, an **error message** is displayed by the print system and the job stops processing. By displaying the message in clear the device points to the reason for the error.



Usually, more information for troubleshooting is displayed on the touchscreen of the printer. (See section 4.3 The Operation Panel of the Device, too.)

The following example of an error message is given with some descriptions. Further error messages are listed on the following page – in addition remedies are listed, too.

Example:

Paper missing in the printer (there isn't any paper of this type/ size in the printer):

Error message:

Load Paper

Remedies:

Fill paper of appropriate type and size to the empty paper feeder (see chapter 3: Paper Handling).
Properly close the tray of the printer.

The print system switches to Online automatically and the job continues processing.

<u>Panel display</u>	<u>Description</u>	<u>Remedies</u>
f.e.:		
[Cover open]		Close the covers of the printer.
[Cartridge Error]	The cartridge is defect or damaged	The cartridge has to be replaced; (see section 6.2: Replacing the Toner Cartridge.

7.3.1. Consumables missing

<u>Panel display</u>	<u>Description</u>	<u>Remedies</u>
f.e.:		
[Load Paper or [No Paper]	Paper missing in the feeder.	Load paper into the empty tray (see chapter 3 Paper Handling).
[Toner low]	Warning.	We recommend to order a new print cartridge when the printer first displays this message.
[Toner Empty !]	The Toner supply is below the minimum quantity now.	Insert a new toner cartridge; see section 6.2: Replacing the Toner Cartridge.
[Toner Waste !]	The waste toner bottle is filled.	Replace the waste toner bottle with a new one. See section 6.3: Replacing the Waste Toner Bottle (Toner Collection Container).

7.4. Print Media Jam

By carefully selecting print media and loading them properly, you should be able to avoid most jams. See the following for instructions on loading print media.

7.4.1. Avoiding Jams

Storing print media

Use the following guidelines to avoid paper feeding problems and uneven print quality.

- Store print media in an environment where the temperature is approximately 20°C (68°F) and the relative humidity is 40%.
- Store cartons of paper on a pallet or shelf rather than directly on the floor.
- If you store individual packages of paper out of the original carton, make sure they rest on a flat surface so the edges do not buckle or curl.
- Do not place anything on top of paper packages.

Loading print media



Please regard the following information to avoid a paper jam:

- Do not open any paper tray while a job is printing!
- Check if the paper has been inserted correctly (see section 3.2).
- Check if the paper is impeccable (the paper must not be creased, damp, dirty or bent).
- Make sure the paper cassettes are not too full (regard the marks at the interior sides of the paper cassettes, see section 3.2).
- Check if the adjustable guides of the paper cassettes are adjusted right.
- If you must print on special paper:
Please regard the hints in section 3.1: Useable Print Media.
- Do not fill different kinds of paper into one cassette.
- The paper paths / paper cassettes must be opened and closed carefully.

7.4.2. Clearing Jams from the Printer

When a jam occurs, the print system displays an **error message** and stops operating.

Example of an error message:

[Paper Jam !]



Usually the touch panel will display hints on the location of the paper jam and provides tips for clearing the jam.

Please regard the following information to remove a paper jam:



- Components inside the printer can be very hot, so please proceed carefully.
- The jammed material has to be removed very carefully from the printer.
- The sheets within all paper paths have to be removed completely.
- Close all printer covers duly.

7.4.3. Clearing Jams in the Conveyor Unit



Caution!

While operating the printer components inside the device will heat up. Take care that you do not burn your fingers when removing a paper jam!

1. Open the front cover of the device.

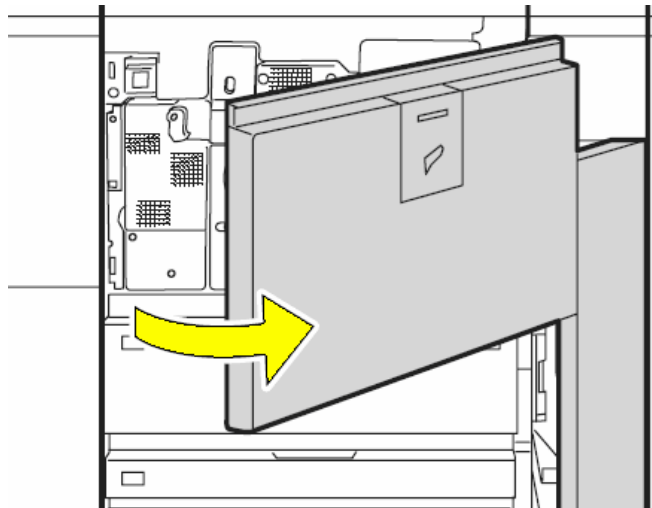

Fig. 7.4.3.a Opening the front cover of the device

2. Turn the knob A in the direction of the arrow (counterclockwise).

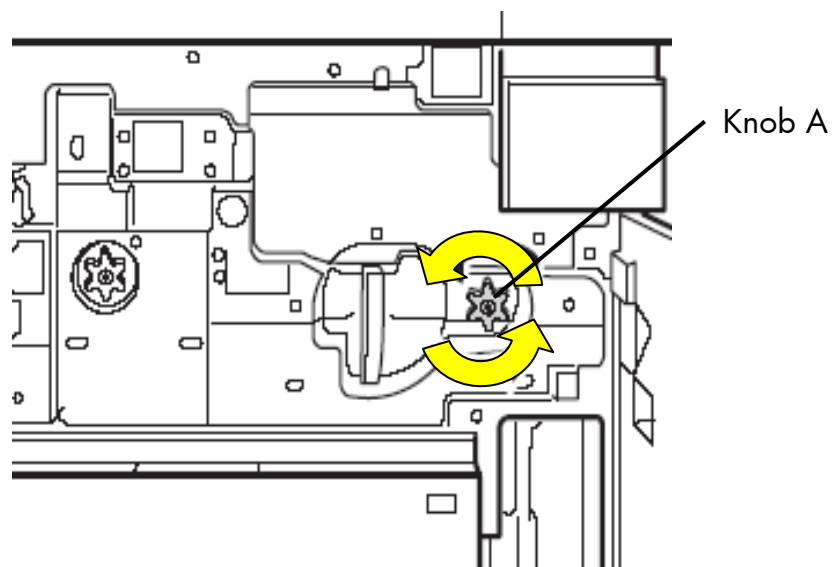
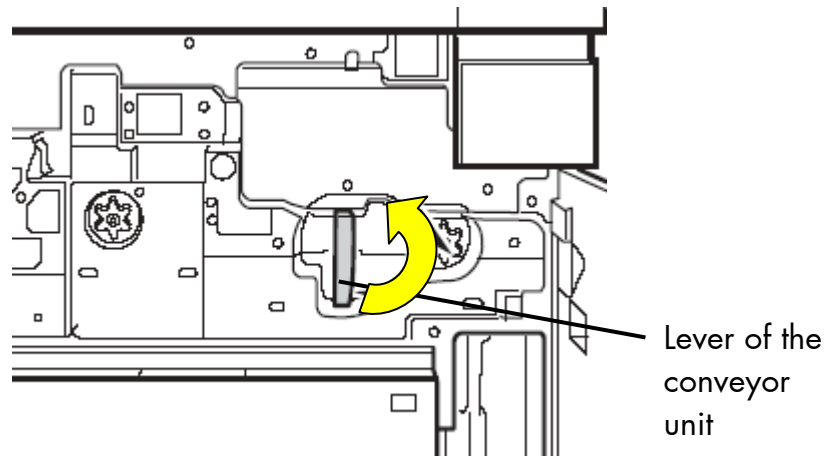

Fig. 7.4.3.b Turning knob A counterclockwise



Be sure to turn the knob A **before** performing the next work step (step 3)! If you perform step 3 without turning the knob, the paper may tear and pieces may remain in the machine.

- Swivel the lever of the conveyor unit counterclockwise (in the direction of the arrow so that it is horizontal).



- Keeping the lever horizontal, gently pull out the conveyor unit until it stops.

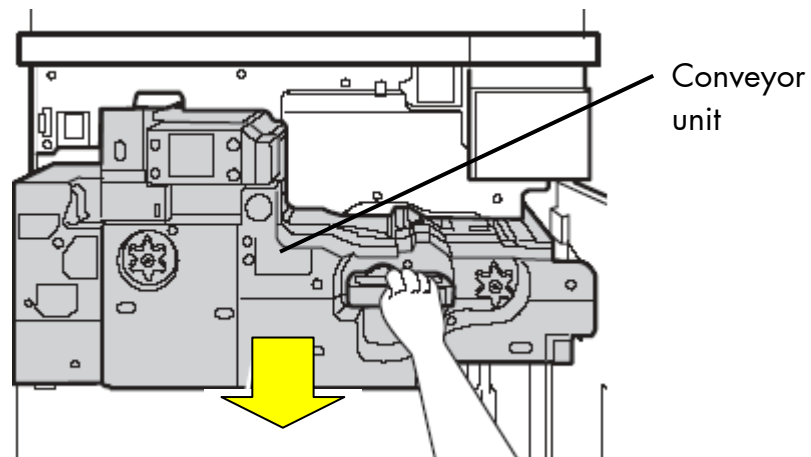

- After pulling the unit all the way out, make sure that the lever points down slightly. This locks the unit. (Note the position of the lever in the following figure).

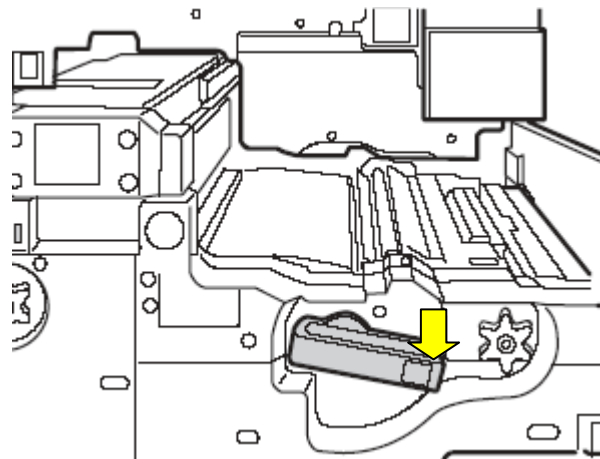

Fig. 7.4.3.e Locking the conveyor unit in the „out“ position



If the conveyor unit is not locked when you remove a misfeed, your hand or fingers may become pinched by the devices.

6. Turn the knob A in the direction of the arrow (counterclockwise).

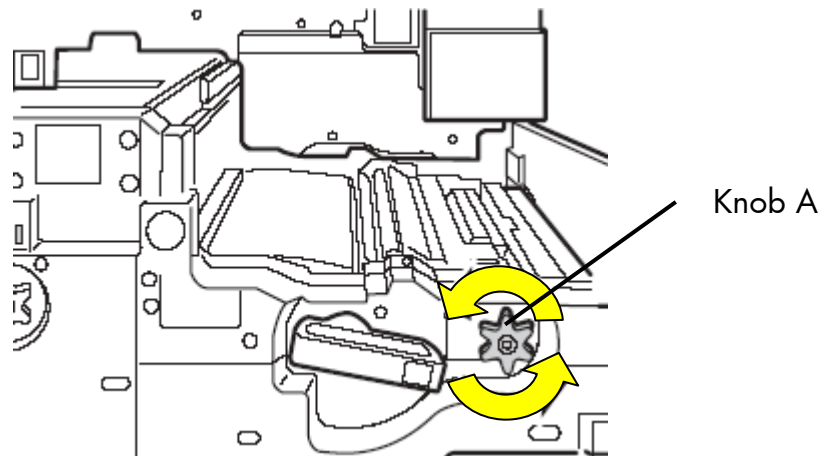

Fig. 7.4.3.f Turning knob A counterclockwise

7. Remove the misfed paper.



When removing misfed paper, do not touch or damage the transfer belt.

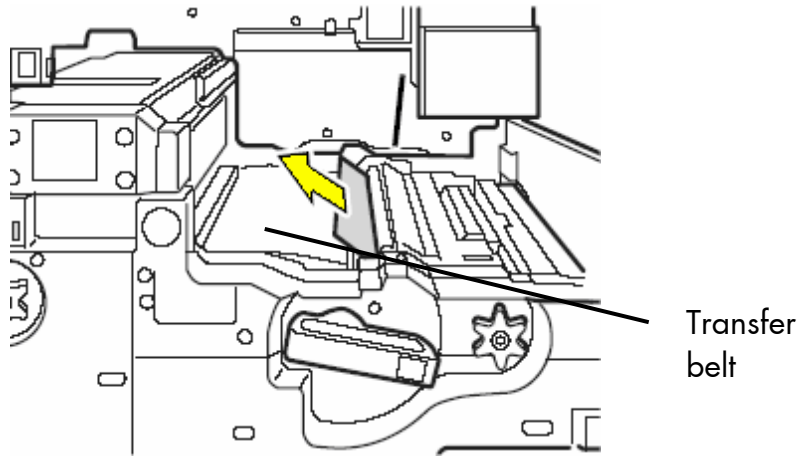

Fig. 7.4.3.g Removing the misfed paper

8. Pull the right paper guide up (in the direction of the arrow).

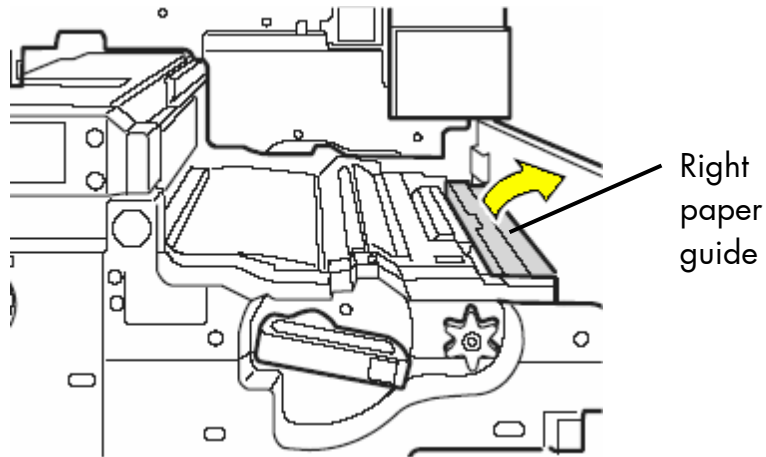

Fig. 7.4.3.h Pulling up the right paper guide

9. Remove the misfed paper.

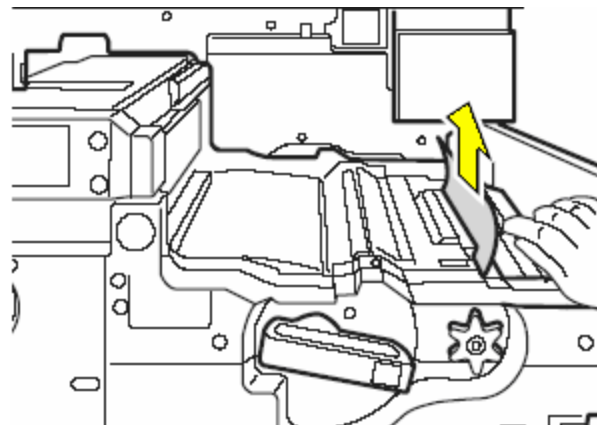

Fig. 7.4.3.i Removing the misfed paper

When released, the paper guide automatically returns to its original position.

10. Pull the left paper guide up (in the direction of the arrow).

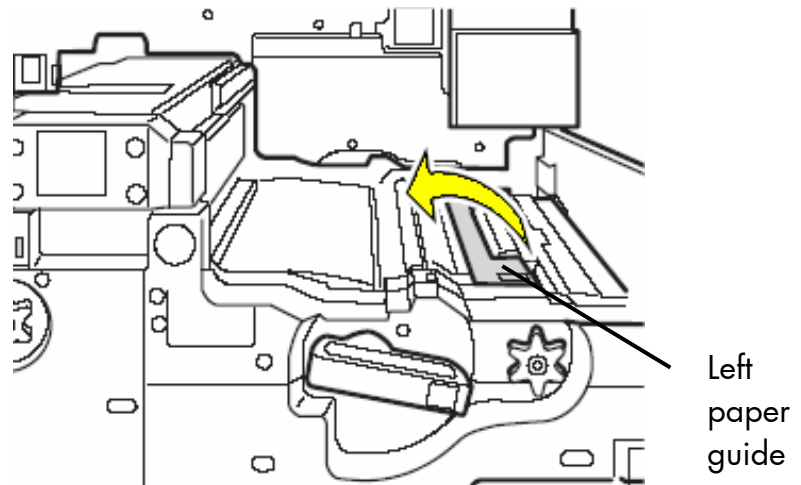

Fig. 7.4.3.j Pulling up the left paper guide

11. Remove the misfed paper.

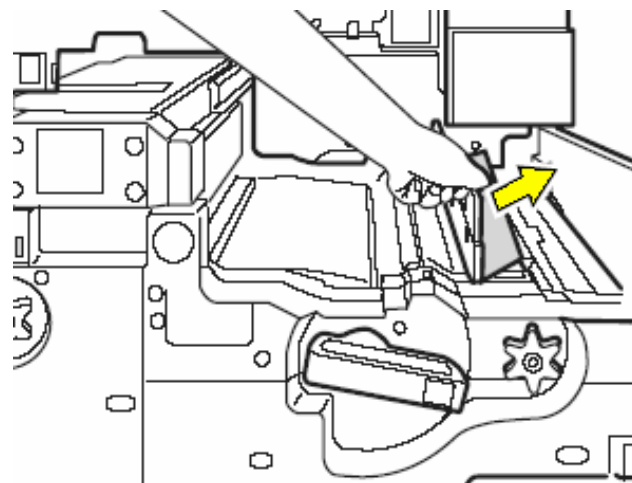

Fig. 7.4.3.k Pulling out the misfed paper

When released, the paper guide automatically returns to its original position.

12. While pressing on the green release lever, open the left part of the conveyor unit.

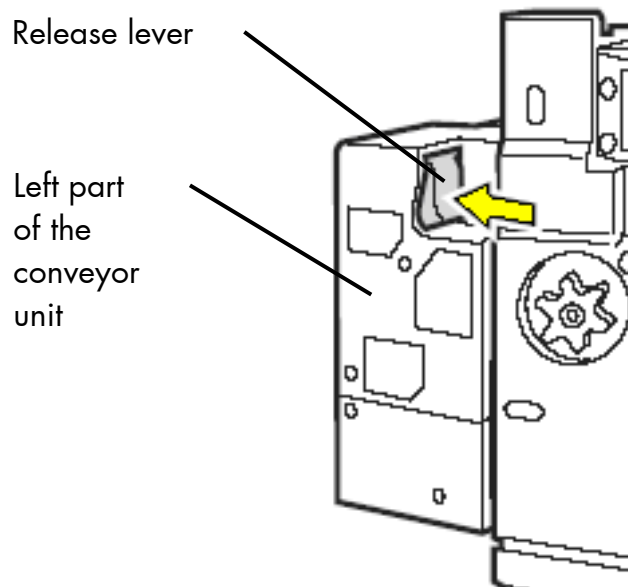

Fig. 7.4.3.l Unlocking the left part of the conveyor unit

13. Gently pull out the left part of the conveyor unit until it stops.

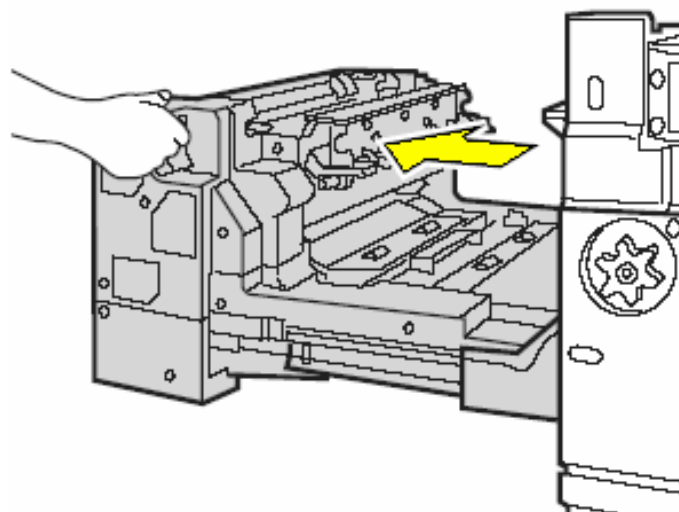

Fig. 7.4.3.m Pulling out the left part of the conveyor unit

14. Turn the knob B in the direction of the arrow (clockwise).

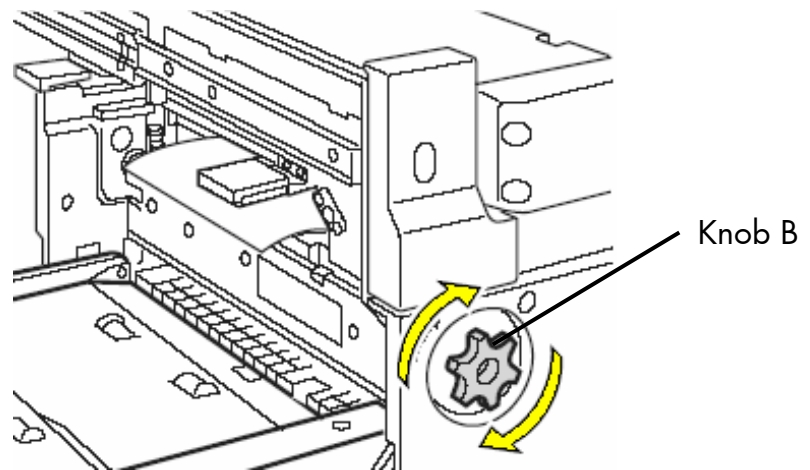

Fig. 7.4.3.n Turning knob B in the direction of the arrow

15. Remove the misfed paper.

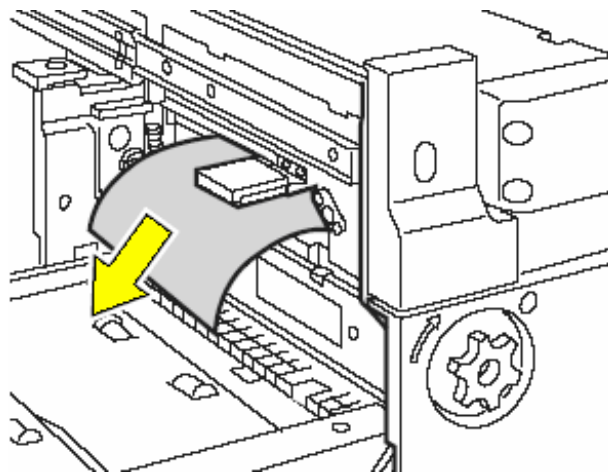

Fig. 7.4.3.o Removing the misfed paper

16. Pull the upper paper guide up (in the direction of the arrow).

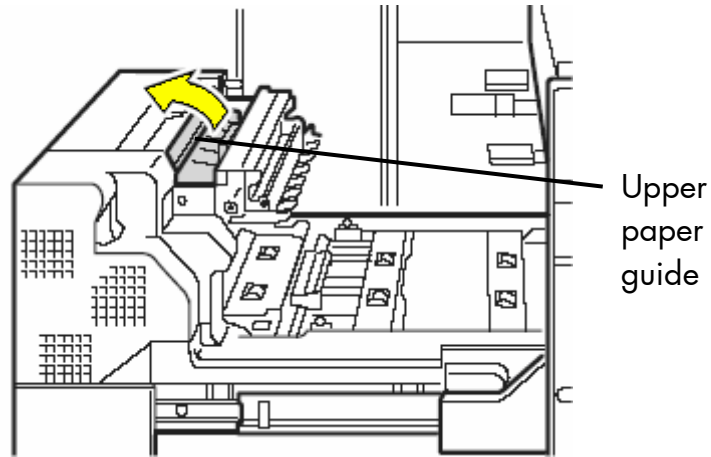

Fig. 7.4.3.p Pulling up the upper paper guide

17. Remove the misfed paper.

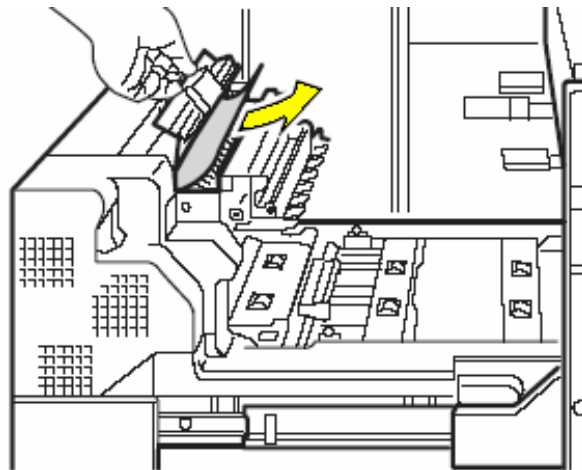

Fig. 7.4.3.q Removing the misfed paper

When released, the paper guide automatically returns to its original position.

18. Open the flap paper guide.

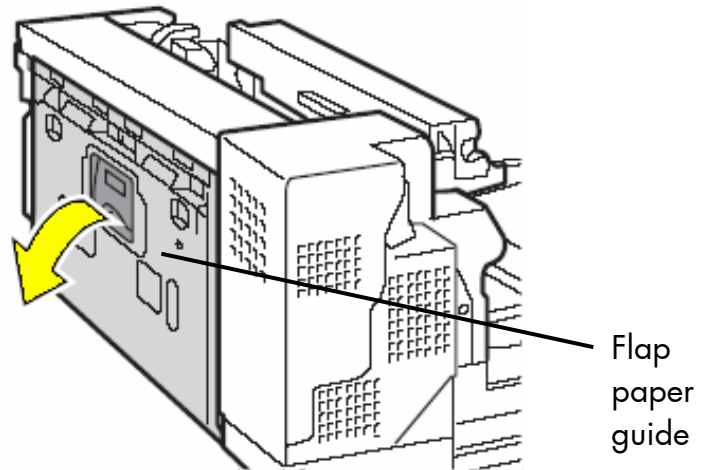

Fig. 7.4.3.r Opening the flap paper guide

19. Remove the misfed paper.

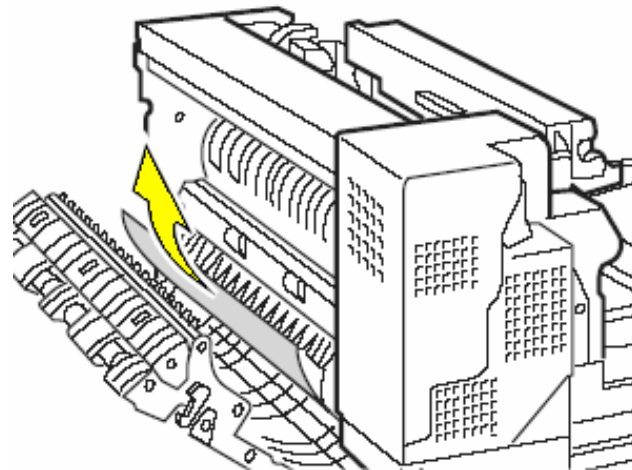

Fig. 7.4.3.s Removing the misfed paper

20. Close the flap paper guide.

21. Pull the lower paper guide up (in the direction of the arrow) and hold it in the upper position.

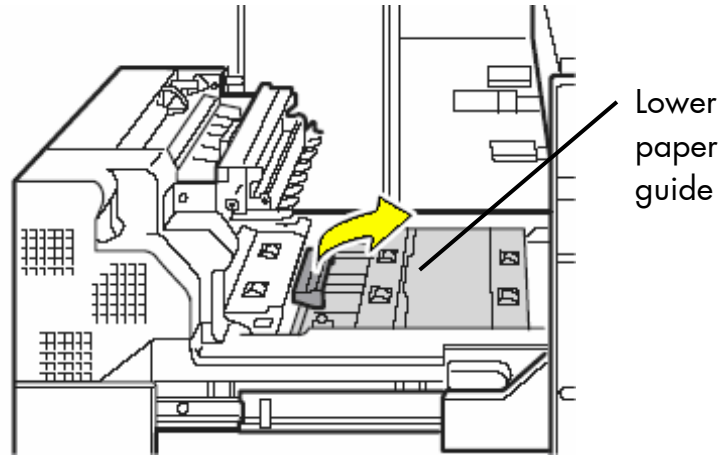

Fig. 7.4.3.t Pulling up the lower paper guide

22. Remove the misfed paper.

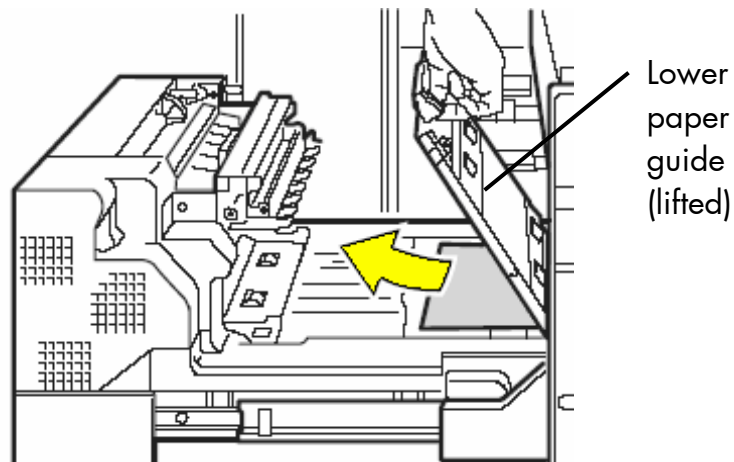

Fig. 7.4.3.u Removing the misfed paper

When released, the paper guide automatically returns to its original position.

23. Pull the little paper guide up (in the direction of the arrow).

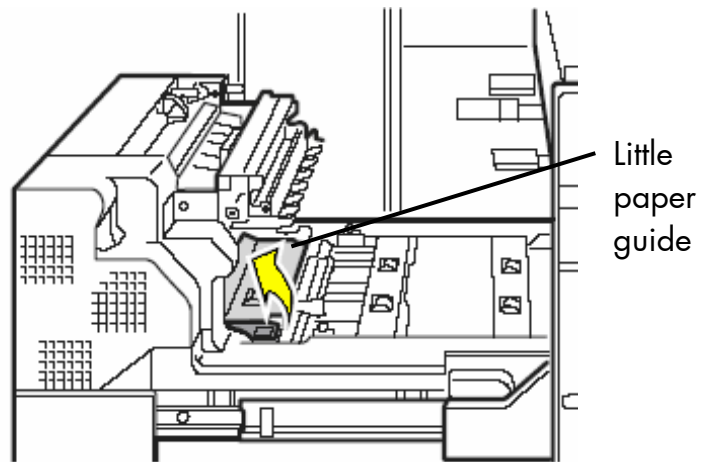

Fig. 7.4.3.v Pulling up the little paper guide

24. Hold the little paper guide and remove the misfed paper.

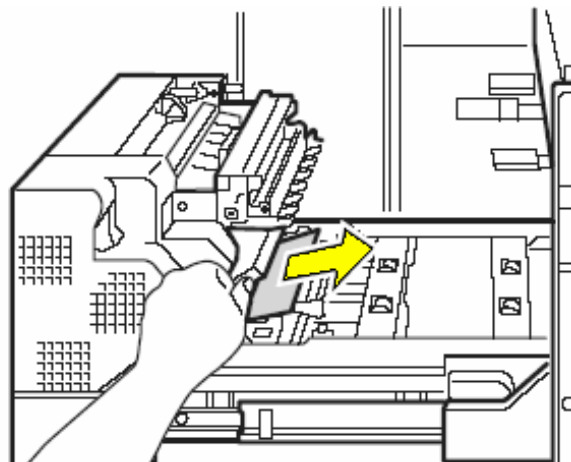

Fig. 7.4.3.w Removing the misfed paper

When released, the paper guide automatically returns to its original position.

25. Gently slide the left part of the conveyor unit all the way in until it snaps into place.

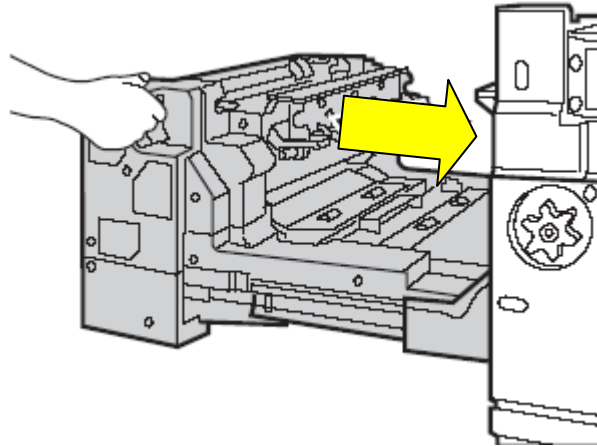

Fig. 7.4.3.x Returning the left part of the conveyor unit to its original position

26. Swivel the lever of the conveyor unit counterclockwise (in the direction of the arrow) so that it is horizontal.

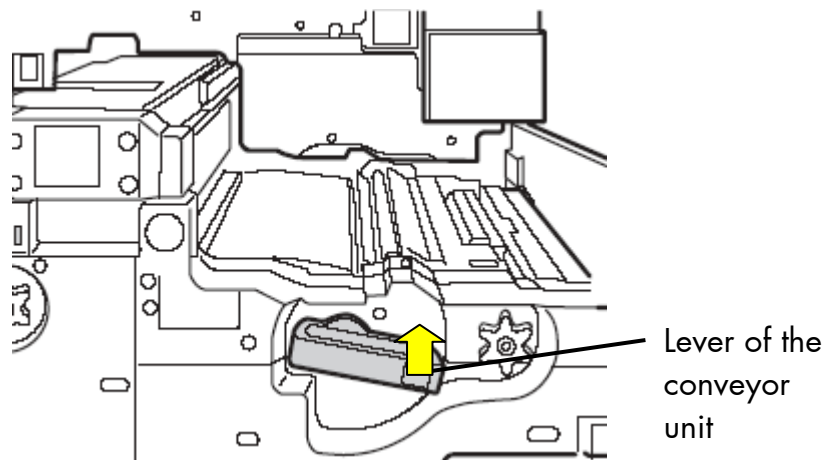

Fig. 7.4.3.y Unlocking the conveyor unit

27. Keeping the lever horizontal, gently push the conveyor unit into the device until it stops.

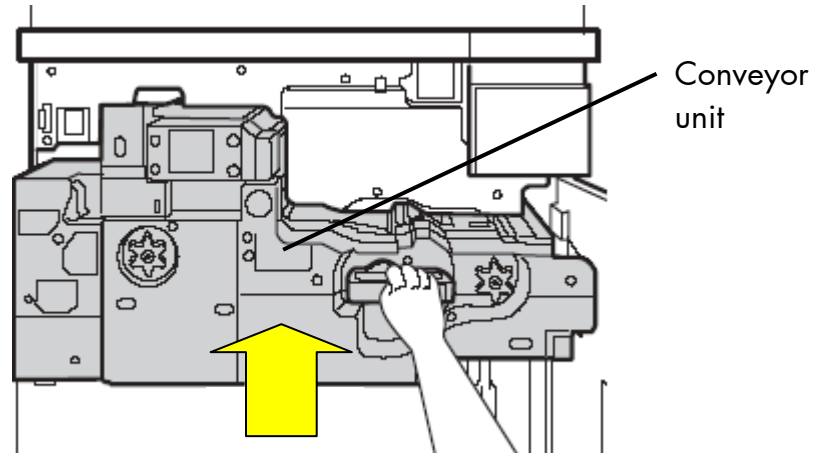

Fig. 7.4.3.z Returning the conveyor unit to its original position

28. Swivel the lever down (clockwise) into the vertical position in order to lock the conveyor unit.

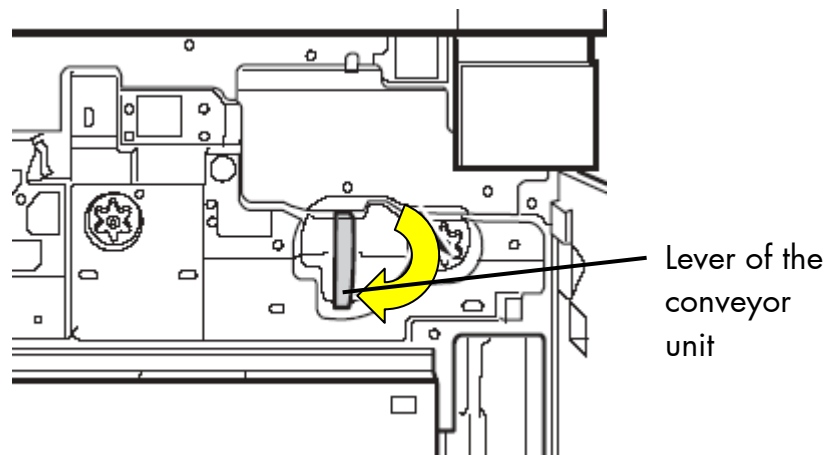

Fig. 7.4.3.za Locking the conveyor unit

29. Close the front cover of the device.

7.4.4. Clearing Jams in the Transport Area

1. Open the front cover of the device.

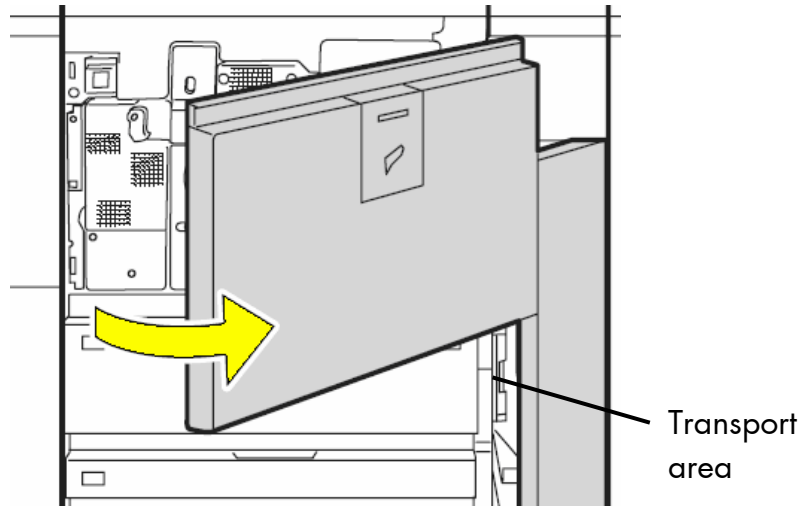

Fig. 7.4.4.a Opening the front cover of the device

2. Press the green release knob and open the paper guide (swivel it as shown by the arrow).

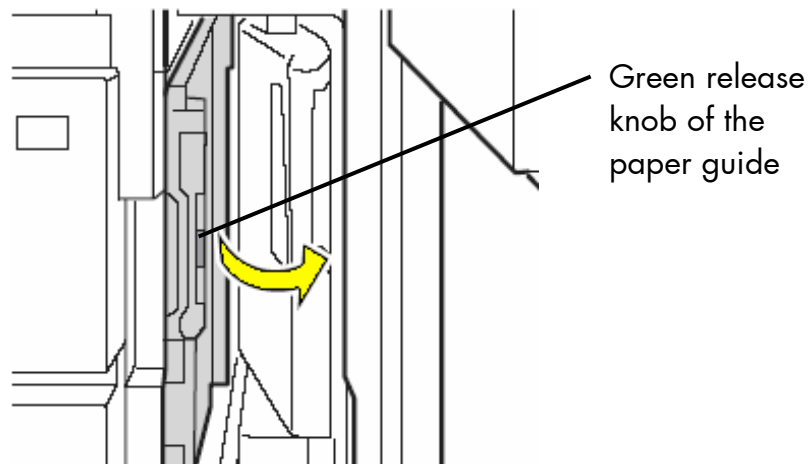

Fig. 7.4.4.b Opening the paper guide

3. Remove the misfed paper as shown in the following figures:

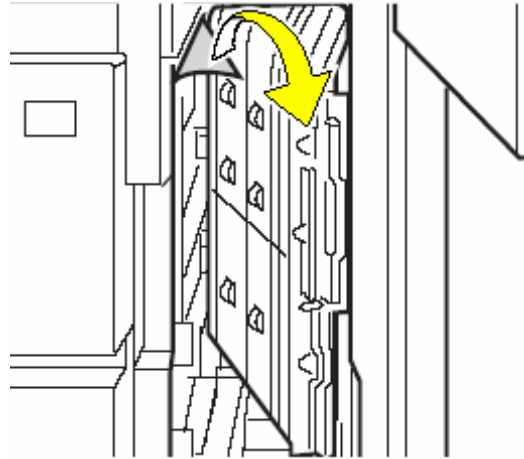

Fig. 7.4.4.c Paper jam in tray 1 or tray 2

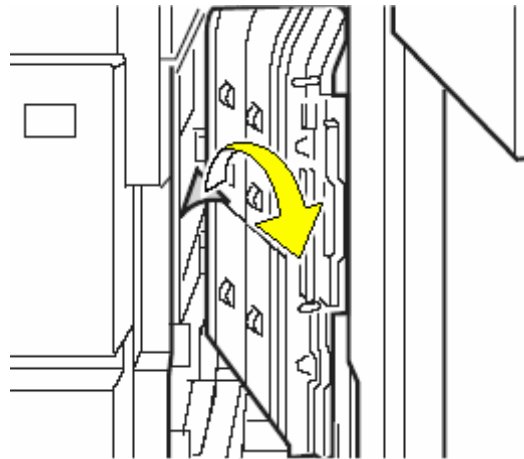

Fig. 7.4.4.d Paper jam in tray 3

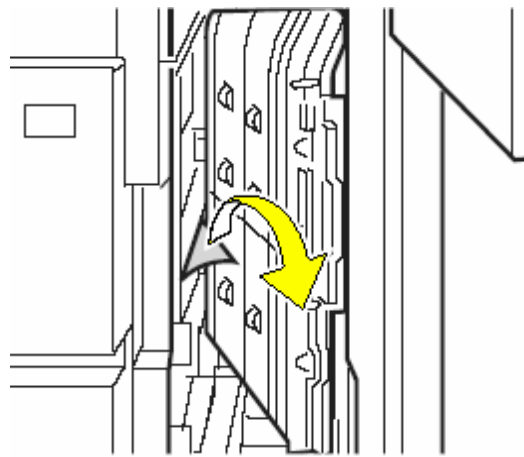

Fig. 7.4.4.e Paper jam in tray 4

4. Close the paper guide.
5. Close the front cover of the device.

7.5. Solving Paper Feed Problems

<u>Symptom</u>	<u>Cause</u>	<u>Solution</u>
Paper frequently jams in the printer	You are using print media that does not meet the printer specifications.	Use recommended paper and other print media. Do not load wrinkled, creased, or damp paper. Flex, fan, and straighten paper before you load it.
	You have loaded too much paper /print media.	Make sure the stack of print media you load does not exceed the maximum stack height indicated at the back of the cassette or on the multipurpose feeder.
	The guides in the selected cassette are not set to the appropriate position for the size print media loaded.	Move the guides in the cassette to the correct position. See section 3.2: Print Media Handling for detailed instructions.
	Paper has absorbed moisture due to high humidity.	Load paper from a fresh package. Store paper in its original wrapper until you load it.

<u>Symptom</u>	<u>Cause</u>	<u>Solution</u>
Paper frequently jams in the printer		Push all cassettes firmly into the printer after loading them. Do not load print media in a cassette while a job is printing by selecting print media from this same cassette.
	The specified output bin is full.	Remove the stack of paper from the output bin as indicated by the operator panel message.
	The paper pick rollers are dirty or worn.	The pick rollers have to be replaced.
The Paper Jam message remains after you remove the jammed print media.	You have not cleared the entire paper path, or you did not open the door to check for jams in this area.	Open the printer doors, clear print media from the entire paper path, and close the doors.

If the remedies above are not successful or there is an error message that is not described in the sections above please switch off the device and contact a MICROPLEX authorized service engineer.

7.6. Print Repeat after an Error

The printer is provided with an automatic jam safety function to prevent a loss of data.

As a standard all the pages being within the printer when an error occurs will be printed again, no data will get lost.

The exact number of pages to repeat depends on the format length and the position where the error occurred on the page.

This automatic jam safety function can be switched off (by changing the EEPROM - configuration) if the user wants to resume the print job at a position he chooses himself. In addition to this see panel function Clearing the Input Buffer (section 5.6).

8. Measures for Transport and Shipping (Repacking)

The Printer is shipped with special packing material and fixing measures. It is recommended to store the boxes and those packing materials.



In case of further shipping or returning of the products they must be repacked in the original way in order to avoid damaging during transportation.

The following list gives you an overview of the working steps necessary for repacking. Pay attention to the notices located on the products and the hints given in the Service Manual as well.



Installation and deinstallation of the print system has to be done by a trained service engineer.

- Remove the printer's optional devices (f.e.: feeder, stacker, optional trays ...).
- Lock all moveable parts of the printer (use all original transport safety devices, adhesive fasteners and so on).

Repack all items in their original packing material and ship them in the original boxes.

9. Specifications

Print technology: non-impact, Laser, OPC, heat pressure fusing

Print speed:	SOLID 90 A3	SOLID 105 A3	SOLID 120 A3
pages/min A4/Letter	up to 90	up to 105	up to 120
pages/min A3/Ledger	up to 47	up to 52	up to 54

Resolution: 300/600 dpi (dots per inch, horizontal and vertical)

Paper size: A5R up to A3W

Paper weight: 60 to 220 g/m² (up to 300 g/m², options are required)

Paper feed:	up to	1,200 sheets	plain paper	(tray 1)
	up to	800 sheets	"	(tray 2)
	each up to	500 sheets	"	(tray 3 and 4)
	up to	100/500 sheets	"	(manual feeder for basic device/ large capacity feeder; both optional)

Stacker: Face-Up/Face-down (configurable)
Finisher (Option): A5R to A3W

Interfaces: LAN: Ethernet 10/100 Mbit (TCP-IP)
serial: USB 2.0 (optional)
parallel: IEEE 1284 (Centronics; optional), SPS-Control (optional)

Size: (the measurements only include the basic device of the print system)

width: appr. 1,084 mm
depth: appr. 790 mm
height: appr. 1,237 mm

Weight: appr. 300 kg

Resumption see next page!

Costs per Page for MICROPLEX Print Systems

The term "costs per page" is the most frequently used one in connection with the purchase of a printer. Nevertheless this term is the one with the biggest lack of definition.

The distributors normally attach great importance to having small values for the costs per page. The user normally wants to have a value that is as realistic as possible.

There isn't any generally valid rule to calculate the costs per page. Therefore values given by different manufacturers are very often not comparable.

The values given by MICROPLEX are based on the utilization time of the so-called consumables of the printer. There isn't any generally valid rule for this calculation, either. Therefore MICROPLEX has fixed the definition of consumables as follows:

1. Consumables

Consumables are parts or substances which the user can exchange or refill without tools.

MICROPLEX understands by this definition that the user can decide by visible criteria when he should exchange or refill consumables. The working steps can be done by the user in accordance with the manual without the usage of tools.

Consumables can be different depending on the printer type. The most important consumable for example is **toner**.

Usually the utilization time of these materials is given as a number of pages (DIN A4). These values often refer to the print density (3%, 4%, or 5%) which is given as an application specific parameter.

Usually a value of 5% print density is defined, very seldom is 4% used.

In the case of a low print density (e.g. 3%) the utilization time increases, in the case of a high print density (e.g. 10%) the utilization time is decreased.

Therefore the utilization time is strongly dependant upon the application. This applies especially to all print systems used in start/stop operation frequently.

Experience proves that in professional applications a print density of higher than 5% is usually reached. For a delivery note containing a form and some bar codes a print density of 8 - 10% is quite normal.

There are further parts that must be exchanged in addition to the consumables during the life time of a print system. MICROPLEX divides these additional parts into two categories:

2. Application specific wearing materials

Application specific wearing materials are parts which have to be exchanged by a service engineer or a trained operator. The criterias for the exchange aren't always easily recognizable for a user. Some of the criterias require measuring techniques or the experience of a service engineer or operator.

In a normal application, parts of this category are:

- fuser unit
- process unit (drum, OPC)
- ozone filter

3. Spare parts

Spare parts are exchanged by the service engineer, when they fail.

Examples for spare parts are:

- couplings
- electronic assemblies
- rollers

Depending on the application some parts may change categories under certain circumstances. If for example very rough paper is used, the rollers can become an (application specific) wearing part.

It's a fact, that the right time to exchange a component depends not only on the failure of a component but also on a possible loss of print quality in the printouts.

MNPSQ = Mean Number of Prints with Specified Quality (**SQ**).

This value is often associated with "Lifetime". This term is not correct. MNPSQ describes the period of time in which a defined print quality is maintained.

The print quality is determined by the values for

- print density
- background darkness
- homogeneity

The value **IQ** (Initial Quality) is used to designate the print quality that is reached with a new printer.

CAQ (Customer Acceptable Quality) is a purely subjective lower limit which a respective customer is willing to accept the print quality. An exchange of parts is only then necessary even if the MNPSQ is already exceeded.

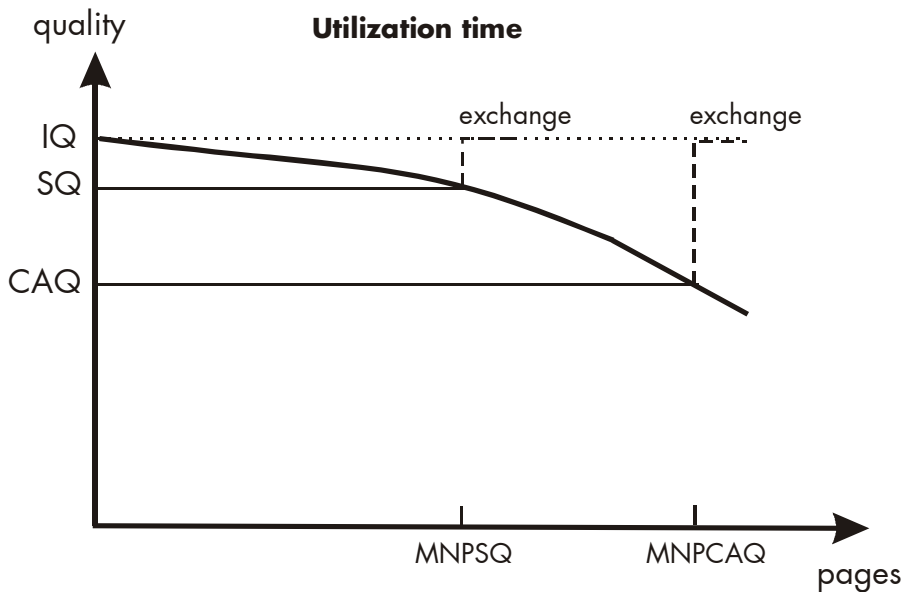

10. Index

B

basic engine 39
bypass tray 33

C

cancel job 75
CE - conformity 11
character spacing 102
characters per inch 102
check list 14
cleaning 107
clearing jams 126
coloured paper 19
configuration 61
connection, printer to PC 40, 57
consumables 19, 123, 149
contents, table of 3
control panel 18, 61
conventions 10
costs per page 149

D

data interface 87
description, general 7
device components 18
diagrams 67
dimensions 15, 147
display language 90
disposal 116
duplex 83

E

emergency power-off 13
emulation 88
ENTER key 60, 63, 64, 65
environment 17, 148
error message 119, 122, 126
ESCAPE key 60, 64, 65, 66
extended menu 62

F

Face Down 82
Face Up 82
factory default 93
feed problems, solving of 142
feeder linking 79
feeder, selection 78
font bank 69
Font List 70
font selection 94
fonts 72
fundamentals 9

H

Hexdump 73
humidity 17

I

input buffer 75, 92
installation 14
installation, first 39
interface 39, 87, 147
interface, connection 16
introduction 7
IP address 58, 103
IP-Panel 56, 58, 59, 61

J

jams, avoiding of 124

L

laser notice 12
line spacing 101
lines per inch 101

M

main power switch 41
mains connection 148
margins 99
max. stack height, tray 23
measures, transport 145
memory distribution 92
menu page 76
menu structure 62
MINUS key 64

N

network parameters 103
Network parameters 58
NEXT key 60, 63, 64
normal paper 19
normal print 74

O

ON /OFF LINE key 60
ON LINE key 60, 63, 66
ON/OFF key 42
operation 39
operation panel 44
operator maintenance 107
output face, selection 82

P

panel display 67
panel elements 59
panel functions 68
panel keys 60, 63, 67
paper feed 147
paper handling 19, 20
paper inserting 21
paper jam 119, 124
paper loading 21
paper size 85, 147
paper tray 18
paper weight 147
permanent configuration changes 61, 65
PLUS key 64
power admission 148
power on 41
power source 16
power supply 39
power switch 18, 41
PREVIOUS key 60, 63, 64
print density 150
print direction 86
print media 19
print media handling 19, 20
print media jam 124
print media, loading 125
print media, storing of 124
print mode 83
print quality 121, 150
print repeat 119, 144
print resolution 71
print speed 147
print system power on 41
printer installation 14, 15

R

recycled paper 19
reduced menu 62
relative atmospheric humidity 17, 148
repacking 145
required space 15
RESET key 60
resolution 7, 71, 147
returning 145

S

safety instructions 12
semi-magazine 33
setup values 65
shipping 145
simplex 83
size 147
sliding pattern 77
spare parts 150
specifications 147
stacker 147
stacker, selection 80
status sheet 68
symbol 10
symbol code 98

T

temperature 17, 148
temporary configuration changes 61
test prints 77
text margins 99
text orientation 97
Toner Cartridge 109
toner collection container 116
toner tray 18
touch panel 18, 44, 61
touchscreen 42
transparent code 91
transport 145
transport damages 14
trays 18
troubleshooting 119

U

utilization time 149

V

voltage 148

W

warnings 122
waste toner bottle 116
WebPanel 45
weight 147