

HENGSTLER

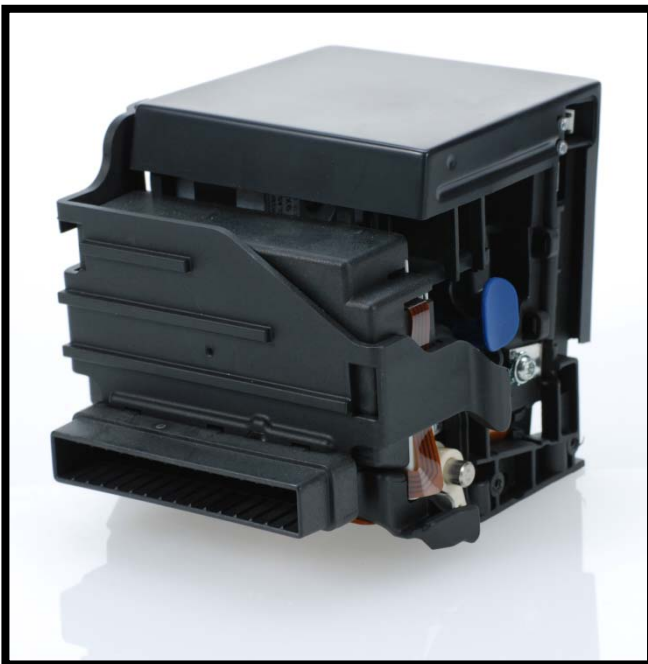

Operating Manual

eXtendo[®]
Thermal Printer Family

Types: X-56 and X-80

E

© 2008-2012 by **HENGSTLER**

Hengstler GmbH has created the text and diagrams contained in this document with care. However, we cannot accept responsibility for any errors or omissions. Notification regarding any errors and suggestions for improvement are welcome. We reserve the right to make technical and other changes at any time in the interest of continual product development.

All information contained in this manual is given without regard to any possible patent protection.

All rights reserved. Reproduction, translation and/or distribution of this document, or extracts thereof, are permitted only by express authorization from Hengstler GmbH. The Hengstler name, "eXtendo" and the Hengstler logo are registered trademarks of Hengstler GmbH and the Danaher Corporation. "Windows" and "Microsoft" are registered trademarks of Microsoft Corporation. Other brand and product names are trademarks or registered trademarks of their respective companies.

HENGSTLER GmbH

Uhlandstrasse 49
78554 Aldingen / Germany
Tel. +49 (0) 7424-89 0
Fax +49 (0) 7424-89 500
e-mail: info@hengstler.com
www.hengstler.com

Document History

Revision	Date	Init	Status	Description
1.00	2008 Jan 28	CBL	Closed	Initial version
1.01	2008 Mar 31	CBL	Closed	Removed excessive warranty value entries under "Features Selected at Time of Order". Corrected figure ref. no. under Wiring, Interfacing. Removed "Heading" format for word "Serial" under Wiring, Interfacing.
1.02	2008 June 27	CBL	Closed	Add note re 15 mm minimum paper length. Removed Basic Firmware option and 130 mm/sec option. Add print speed of 130 mm/sec max. for 12/10-36 VDC models. Change 10-39 VDC to 10-36 VDC. Change Printhead Position description to describe three positions. Troubleshooting section expanded. Black Mark text clarified. Cutter Operation text clarified. Change sleep mode current spec to 50 μ A.
1.03	2009 Jan 25	CBL	Closed	Corrected formatting of columns in serial and USB cable pinout tables. Company logo changed from graphics to text. Add duty-cycle specification. Add photo of USB and Multivoltage version for connector positioning. Add description of connectors on gear side. Modify paper roll holder text. Modify text to match new photos. Add note re specifications under Power Supply section. Update paper roll holders in option chart. Added paper roll holder drawing reference. Add schematic fragment for PVE/Aux. sensor connection. Add registered trademark symbol (®) to "eXtendo".
1.04	2009 Feb 20	CBL	Closed	Revise printhead position to two positions (three positions used in prototypes only). Add "printhead up" status to LED Indicators. Revise Head Status Sensor to reflect no printing when printhead is up. Troubleshooting section revised re printhead up operation. Added printing current specs under Technical Specifications.
1.05	2009 May 15	CBL	Closed	Add section on low current operation. Add FCC Part 15 statement. Add EN55022, EN55024 statements. Add two "General Information" points. Add "Function" section. Add cable length limitation to interface specs. Add warning with photo about damaging cutter bracket when improperly mounted. Remove "Available soon" from Linux driver reference in intro. Add fanfold paper reference in "Paper" section. Add explanation for moving cutter blades manually.
1.06	2010 July 19	CBL	Closed	Add note about no serial handshaking with sleep mode. Add explanation of chute sensor/partial-cut. Add mounting hole diagram and expand mounting comments. Update cover photo. Add installation of paper guide.
1.07	2011 April 21	CBL	Closed	Changed P/N of paper spec document. Correct voltage in print speed specifications. Increase 24 VDC print speed to 350 mm/sec.

1.08	2012 Aug. 8	CBL	Closed	Add clarifying statement re Class B emissions. Add statement about sunlight on chute sensor. Add definition of area in line with black mark where only certain inks may be used. Added drawing of PPE sensor.
1.09	2015 Oct. 5	Eli	Closed	Serial data cable pinout corrected. 12V and 10-36V options removed for X-80. Sensor position 3 in X-56 shifted left.

Table of Contents

1.	Introduction	7
1.1.	Additional Documentation	7
2.	Important Information and Safety Instructions	8
2.1.	General Information	8
2.2.	Systems Specific Safety Instructions and Symbols	8
3.	Overview	9
3.1.	Overview of Thermal Printing Technology	9
3.2.	X-56 versus X-80	9
3.3.	Functional View	10
3.4.	Description of Components and Operation	10
3.5.	Location of Controls and Connectors	11
3.6.	Operation of Sensors and LEDs	14
3.6.1.	Paper Entrance / Black Mark Sensor	14
3.6.2.	Paper Pre-End (Paper Low) Sensor Option	15
3.6.3.	LED Indicators	17
3.6.4.	Head Status Sensor	17
3.6.5.	Chute/Jam Sensor (Optional)	17
3.7.	Features Selected at Time of Order	18
3.8.	Graphic Printing vs. Printing with Printer's Fonts	19
4.	Unpacking	20
5.	Major Options	20
5.1.	Sleep Mode	20
5.1.1.	“Go To Sleep”	21
5.1.2.	“Wake Up”	21
6.	Installation	22
6.1.	Function	22
6.2.	Mounting Printer	22
6.3.	Installing Paper Guides	23
6.4.	Wiring	24
6.4.1.	Power	24
6.4.2.	Interfacing	25
6.5.	Paper Supply	26
6.5.1.	Hengstler Paper Roll Holders	26
6.5.2.	Designing Your Own Paper Roll Holder	26
6.6.	Power Supply Specifications	27
7.	Operation	27
7.1.	Loading Paper	27
7.2.	Printhead Position Control	27
7.3.	Paper Advance Wheel	28
7.4.	Print Speed	28
7.5.	Cutter Operation	28
7.5.1.	Partial Cut with Chute Sensor	29
7.6.	eXtendo [®] Digital Tools	29
8.	Low Current Operation	30
8.1.	Print Speed	30
8.2.	Graphics/Bar Codes	30
8.3.	Reverse Printing	30
8.4.	Dot History Factor	30
8.5.	Burn Time Correction	30
8.6.	Multi-Strobe Factor	31
8.7.	Print Density Adjustment	31
8.8.	Sleep Mode	31
9.	Troubleshooting	31
10.	Maintenance	32
11.	Repair	32
12.	Buying Paper	32
12.1.	Sourcing Paper	32

12.2.	Converting Paper	32
12.3.	Black Mark Sensor Location	33
13.	Technical Specifications.....	34
13.1.	General Specifications (X-56 and X-80)	34
13.2.	X-56 Specifications	35
13.3.	X-80 Specifications	35
13.4.	Electromagnetic Compatibility.....	36
13.4.1.	FCC Part 15 Class B Device.....	36
13.4.2.	EN55022 – Emissions	36
13.4.3.	EN55024 – Electromagnetic Susceptibility	36
13.5.	Printer Drawings.....	36

1. Introduction

Thank you for selecting the Hengstler eXtendo[®] thermal printer! We are proud of this feature-rich product, which was designed using all our expertise and experience, and we are confident that you will be pleased with the advanced features and outstanding performance.

This Operator Manual is designed to help you with the proper installation, connection to your host computer system and start-up of the eXtendo[®] thermal printer system. All necessary details will be explained in the following sections. Please read this manual carefully before using the printer. If you have any further questions, please do not hesitate to contact us.

The eXtendo[®] thermal printer family does not require any servicing and is intended primarily for printing and cutting documents and receipts from continuous thermal paper. The X-56 version is for narrower paper (49 – 60 mm), while the X-80 handles wider paper (60 – 86 mm). Various paper cutters are available to handle a wide range of paper stocks up to 250 g/m² and more. Powerful motors allow the use of large paper rolls to maximize time between paper replenishment. An optional presenter (available soon) prevents the user from touching the paper until it is cut from the paper roll, thereby preventing many forms of vandalism. If documents are to be printed on preprinted forms or with a predetermined length, 'Black Mark' control is available. The horizontal and vertical print density is 203 dpi so that graphics, such as logos etc. can be printed with good quality.

The eXtendo[®] printer family has been designed for use in a wide variety of applications, including ticketing, parking, banking, transit, reverse-vending, kiosk, car wash, fuel dispensing, and vending applications. In order to provide the optimal cost/benefit ratio, the eXtendo[®] family of printers allows you to choose and buy only the features that you need for your application! This extreme customization insures that you have just the right amount of printer for your task; not too much, and not too little.

Available in both USB and Serial (RS-232) configurations, the eXtendo[®] printer family is one of the most versatile we've ever produced! Driver software is available that supports the Windows XP and Linux operating systems. In addition, the printer can also be activated directly in ASCII mode through ESC sequences; a detailed description of the different sequences is contained in the eXtendo[®] Emulation Command Set Reference.

We're glad you chose the eXtendo[®] thermal printer family. Once you've used it, we're sure you will be, too!

1.1. Additional Documentation

Document No.	Description
D 684 112	eXtendo [®] Emulation Command Set Reference
D 684 128	eXtendo [®] Paper Specification
D 684 090	X-56 Dimensional Drawing – Twincut Cutter
D 684 098	X-56 Dimensional Drawing – Rotary Cutter
D 684 091	X-80 Dimensional Drawing – Twincut Cutter
D 684 099	X-80 Dimensional Drawing – Rotary Cutter
D 684 152	100 mm Paper Roll Holder Drawing
D 684 154	150 mm Paper Roll Holder Drawing

2. Important Information and Safety Instructions







Hengstler GmbH accepts no liability for any damages, direct, indirect or consequential, arising from improper use of this thermal printer, and, in particular, due to non-compliance with this operating manual or any other available documentation or due to improper handling or maintenance. Should Hengstler GmbH choose to make technical documentation available, this does not imply any authorization, implied or stated, for the making additions, repairs or modifications to this printer.

This documentation may not be copied, nor shall its contents be disclosed or used commercially unless such use has otherwise been explicitly agreed to by a duly authorized Hengstler representative in writing.

The user is responsible for proper handling and installation of this printer. The printer should only be shipped in its original packing.

2.1. General Information

Hengstler GmbH accepts no liability for the safe operation of the eXtendo[®] thermal printer family unless Hengstler original products are used exclusively and the following instructions and recommendations are heeded.

-  If unauthorized persons perform any repairs or modifications to the printer mechanism and the controller, HENGSTLER will not accept any liability and the guarantee shall be void.
-  Unapproved types of thermal paper may dramatically reduce the life of the print head and may cause the guarantee to expire. For pre-printed thermal paper make sure that only appropriate inks are used. Detailed can be found in the Hengstler Paper Specifications document D 684 122.
-  The DC power connector must not be plugged in or disconnected under load in order to avoid damage to the electrical components and the thermal printhead.
-  Avoid strong vibration, shock and impact since they may damage or destroy sensitive electronic and mechanical components. Do not touch the surface of the printer control board in order to prevent static electricity from damaging sensitive components.
-  This thermal printer must not be used near to high-frequency apparatus or strong magnetic fields in order to prevent undefined magnetic disturbance.
-  Do not make any attempts to service this printer (e.g. change paper) while the printer is printing.
-  Installing or uninstalling the printer must only be done while using adequate ESD protection.

2.2. Systems Specific Safety Instructions and Symbols

The following symbols on the system and in the manual remind you to follow the relevant safety instructions:



General warning for cases where the user or a service person may be in danger.

-  General notes and hints for operating the system safely.

3. Overview

3.1. Overview of Thermal Printing Technology

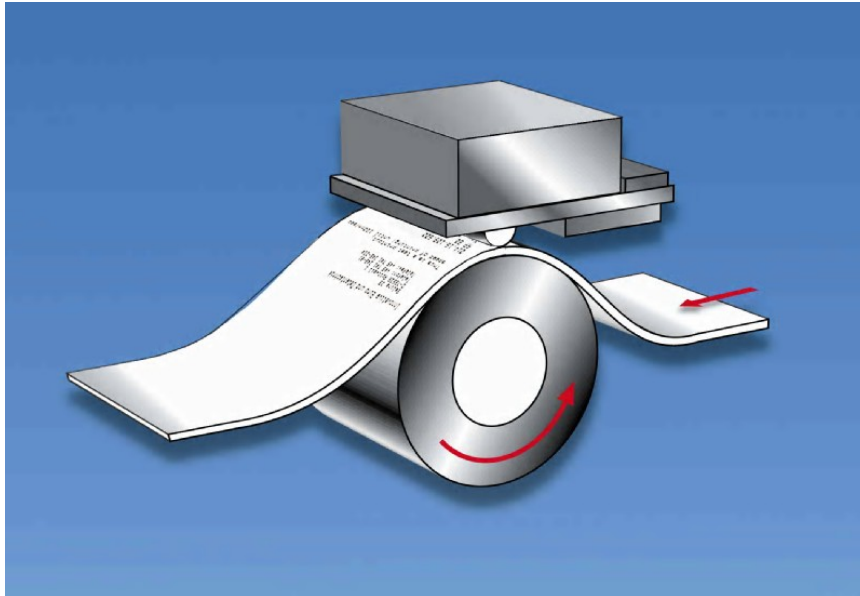

A brief overview of thermal printer technology might be helpful to understand how the eXtendo[®] thermal printer family works. In most direct thermal printers, paper is fed over a soft, rotating platen and under the thermal printhead. The platen acts as a roller to advance the paper at the same time it acts as a surface against which the spring-loaded printhead presses the paper to insure good thermal conductivity. Circuitry in the printer determines which heating elements to activate (“fire” or “burn”) to form the next row of dots on the paper.

The thermal paper is coated with several compounds. At room temperature, these compounds are white in color and do not react with each other. The heat from the thermal printhead acts as a catalyst in the areas where the small printhead dots are fired, causing these compounds to react with each other and form a new compound which is a contrasting color, usually black. The platen then advances the paper to the position of the next dot row, and the process is repeated.

You may note immediately several of the advantages of thermal printing. First, since the printing is done with heat, there is no noise from the printing process itself. Thermal printing is inherently quiet compared to most other technologies, such as impact dot matrix. Also, there is only one moving element in the thermal printer: the platen. This provides increased reliability and life when compared to other technologies.

3.2. X-56 versus X-80

The X-56 and X-80 thermal printers are based on a single design concept and share many components. The difference between them is primarily in the width of paper that they will print and cut. The X-56 handles paper of between 49 and 60 mm in width, while the X-80 accepts paper from 60 to 86 mm wide. Narrower paper than the widest specified above is accommodated by the use of paper guides to provide additional positional guidance.

This causes one specific minor difference between the two printers. The maximum paper width the X-56 will accept is 60 mm, and paper guides are not needed for paper in this width

range. 58 mm and 60 mm paper widths are very common, and are considered standards. Paper guides are not needed to handle these two paper widths.

The X-80 has a maximum paper width of 86 mm. While 86 mm wide paper may sometimes be used, the most common larger paper widths are 80 mm and 82.5 mm (3¼ inches). These **do** require a paper guide to use. This, then, is one of the most obvious differences between the two printers. The X-56 does not come with paper guides, though they may be ordered separately. The X-80 is always shipped with paper guides, since they are needed for the most common paper widths.

Current consumption is also a difference between these two printers. Because of the greater number of heating elements (dots) that can be fired simultaneously in the X-80 (the 203 dpi version of the X-80 has 640, while the same resolution version of the X-56 has 448), the current consumption can be higher by 43%. This does not mean the X-80 current is always higher, however. Current consumption is controlled by many factors, most importantly by the density of what is being printed. For example, if the same receipt is printed on an X-56 and X-80, the current consumption will be approximately the same, since the same number of dots is being fired on both printers.

Current consumption is also affected by whether the heating elements are fired as one block, the burn time (the length of time that the dots are on), whether graphics are being printed, whether sleep mode is employed to reduce current, and other factors.

3.3. *Functional View*

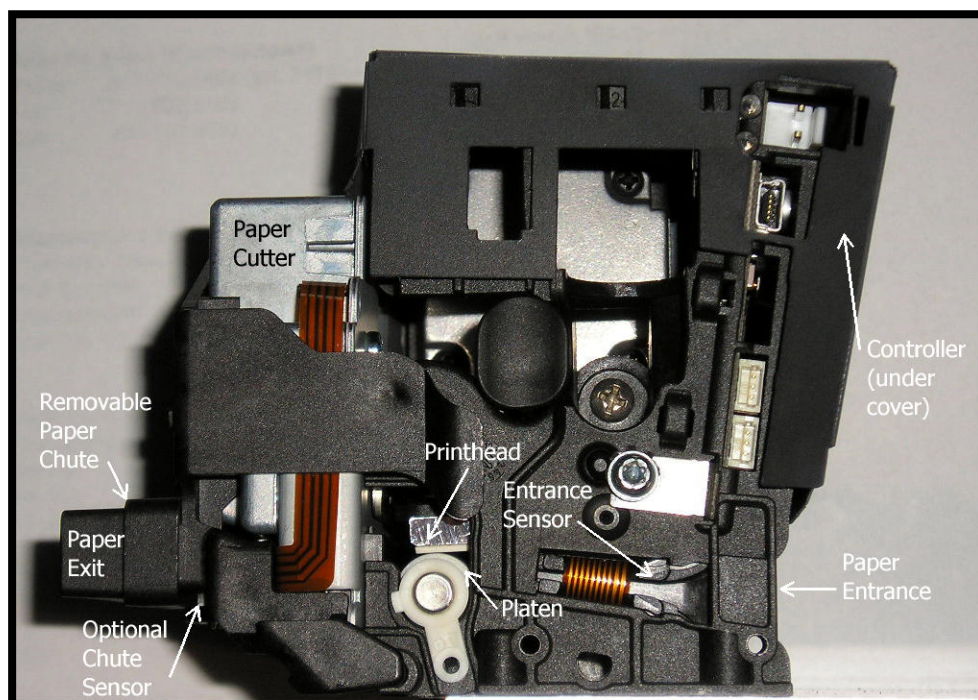

Figure 1

3.4. *Description of Components and Operation*

There are several key components or modules to the eXtendo[®] family of thermal printers. (Please refer to Fig. 1.) The thermal printhead is positioned above the platen. The platen acts as a roller to advance the paper at the same time it acts as a surface against which the spring-loaded printhead presses the paper to insure good thermal conductivity. The interface, motor used to turn the platen (not visible in Fig. 1), sensors, printhead, and paper cutter are all connected to the controller, which sends commands and causes these components to

function at the proper time. The cutter separates the paper from the paper roll when instructed to do so. Several sensors monitor progress as the printed document is created. All these items are mounted in a conductive plastic housing to discharge any static and to provide electrical noise shielding.

The paper chute is a short chute protruding from the front of the printer. It snaps in and out without tools. The paper chute should be present for most normal printing applications, but it should be removed for applications where the printed document is expected to fall freely into a chute or other pathway. In these cases, the chute may interfere with the free fall of the printed document. Please note that the optional chute/jam sensor is located just before the chute, so removing the chute does not prevent the chute/jam sensor from being ordered.

When paper is inserted, the entrance sensor detects its presence and signals the controller. The controller causes the paper advance motor to turn the platen to draw paper into the printer. As soon as the paper reaches the platen, the paper is pulled under the printhead and printing can begin. The paper continues to advance and enters the paper cutter, where it passes between the cutter blades and out the print chute. If the customer has ordered the feature, it passes first over the optional chute/jam sensor. Once printing is completed, the paper is advanced and a command sent to the cutter to cut off the paper. The paper then retracts to a park position to avoid wasting the paper between the printhead and cutter.

When the printer runs out of paper, the entrance sensor detects the fact. The controller then immediately stops printing and backs the paper up so it protrudes from the back of the printer. This is to allow the operator to raise the printhead, remove the partially printed document, and lower the printhead before loading a new roll of paper. If this were not done, it would be possible for short pieces of paper to remain in the paper path without the operator's knowledge, eventually causing an obstruction and a paper jam.

The optional chute/jam sensor continually monitors whether there is paper in the chute, and can be read via the Status function. Please see the eXtendo® Emulation Command Set Reference D 684 112 for details. This function is often used in conjunction with the host's peripherals to signal the user when a printout is not taken. Examples where this is important include when the information is confidential, or the printout can be redeemed for cash or items of value.

Additionally, the optional chute/jam sensor is monitored while first printing after a cut. After a cut, the printer "knows" where the end of the paper is. As printing takes place, the printer also "knows" how many paper advance steps have been made, and approximately when the end of the paper should reach the chute/jam sensor. If the paper does not reach the sensor when expected, the printer assumes that a paper jam has taken place and signals this fact via the Status command.

3.5. Location of Controls and Connectors

Please see Figures 2, 3, 4 and 5 below for the location of connectors, indicators and controls on the eXtendo® series. Figure 2 shows a USB version of the eXtendo®, while Figure 3 shows serial/RS-232 version. Figure 4 shows the upper portion of a serial version equipped with both the 10-36 volt range option and the Sleep Mode option. Figure 5 shows the opposite side of an eXtendo®, showing the Paper Advance Wheel and the Paper Pre-end/Paper Low Sensor connectors. Please note that the Paper Pre-end/Paper Low Sensor connectors are duplicated on both sides of the printer to make connection convenient regardless of which side of the printer might be near the cabinet side wall.

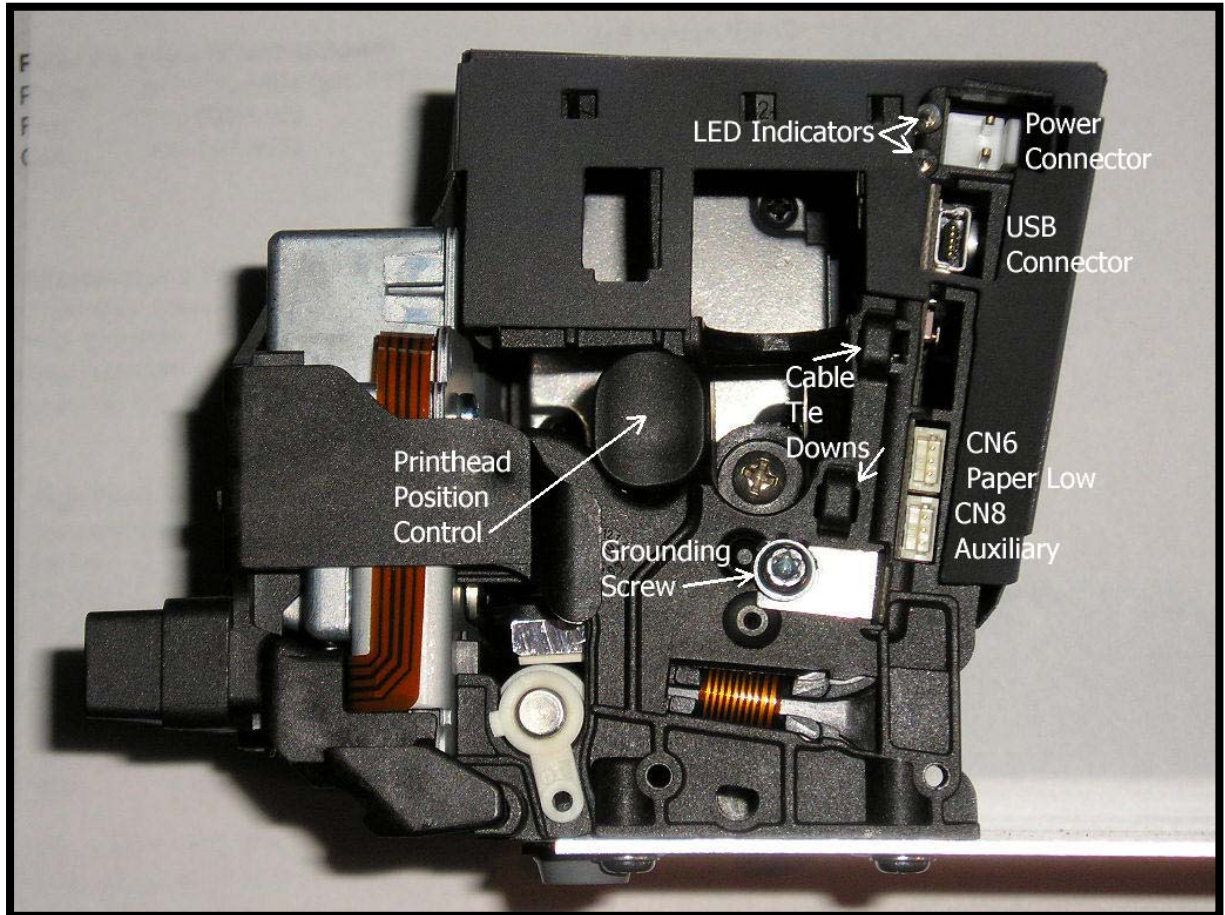

Figure 2

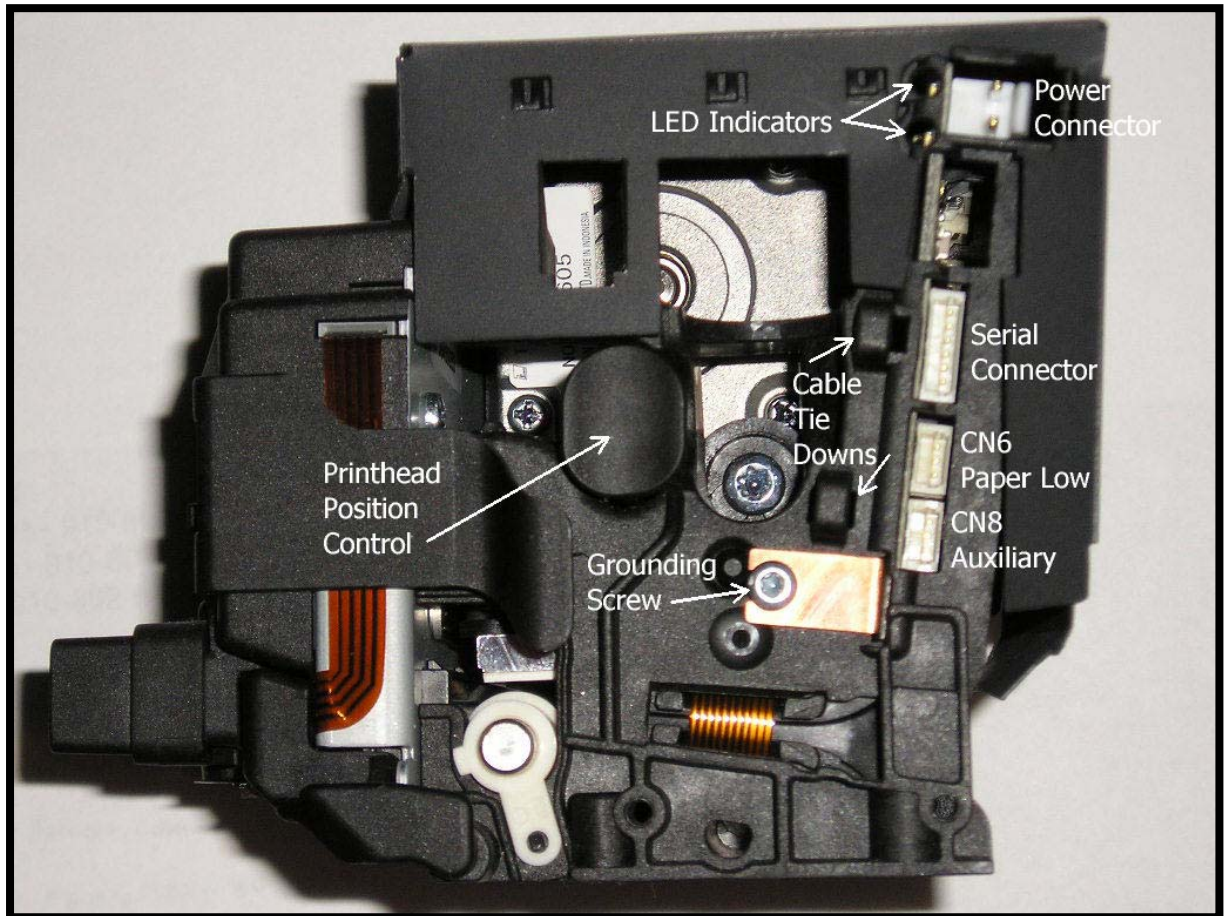

Figure 3

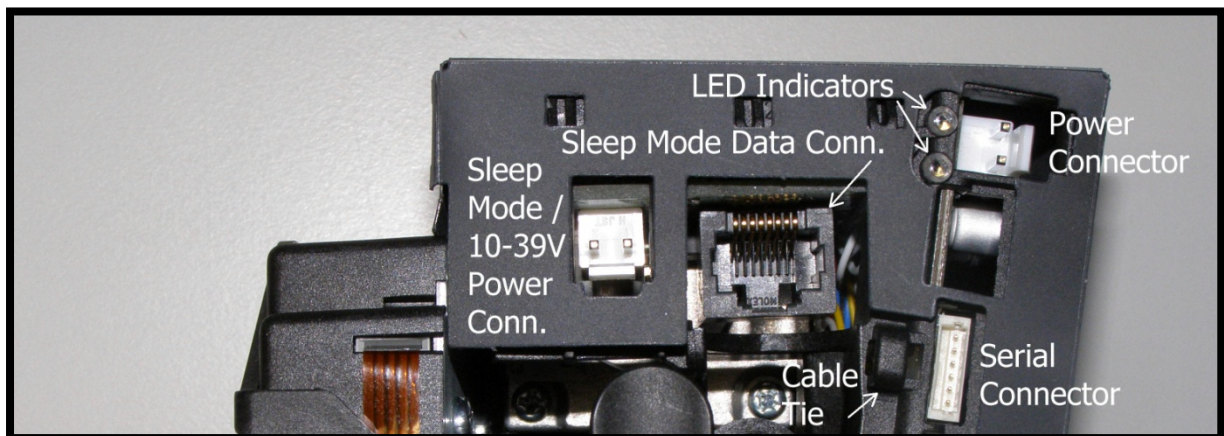
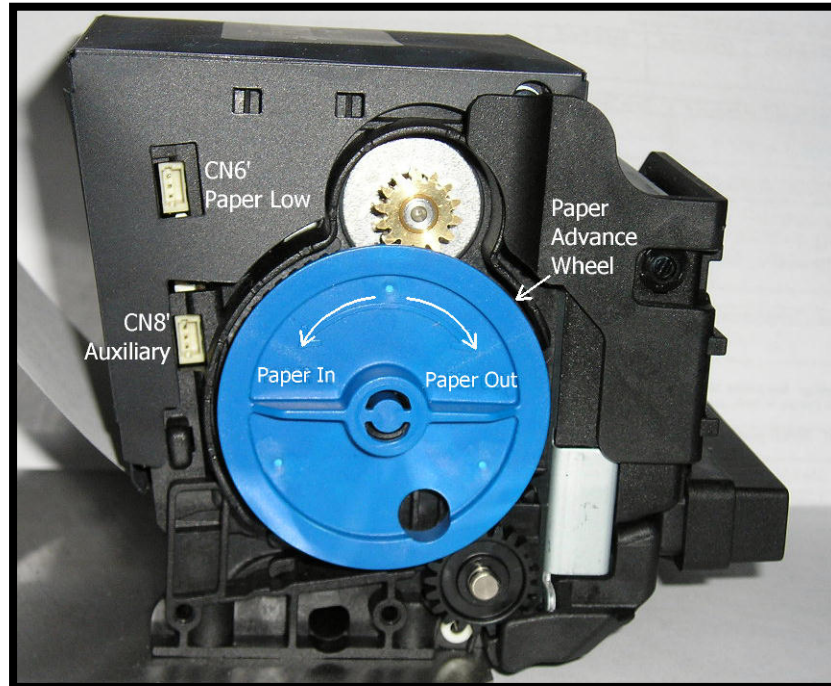

Figure 4

*Figure 5*

3.6. Operation of Sensors and LEDs

3.6.1. Paper Entrance / Black Mark Sensor

There is a sensor in the paper entrance area that serves several functions. First, it detects paper during paper loading and signals the printer to begin the paper autoloading function. Similarly, when the printer is out of paper, this sensor detects the fact and signals the printer accordingly.

The same sensor is also used to detect Black Marks. Black Marks are blackened areas placed on the paper during the converting process. They are generally used, in conjunction with appropriate printer commands, to advance the paper to a specific position after each print job. One common reason for this is to so that preprinted information is properly located with respect to information printed by the printer itself, for example, printing inside a preprinted box. Black marks can be located on the thermally coated side of the paper (where printing takes place) or on the back of the paper, depending upon the location of the sensor.

The eXtendo[®] series of printers is designed to allow for numerous Paper Entrance/Black Mark sensor locations during manufacturing. (The location of this sensor cannot be changed once the printer is built.) Also, two different sensor types can be used. The most common is the reflex or reflective sensor, where the light source and detector are located on a single chip. Basically, the light strikes the white paper surface and reflects back into the sensor. If enough light reflects to activate the sensor, the printer concludes that paper is present. If there is not enough light reflected, the printer assumes that this area is black, meaning the printer is on a black mark or the printer is out of paper. There are six (6) different possible positions for this sensor in the X-56 and ten (10) in the X-80. Half of these positions sense the coated side of the paper, while the other half sense the back of the paper. The positions of these sensors are detailed in the Paper section of this document.

The eXtendo[®] can also use a through-beam sensor in OEM applications. This type of sensor has a light source on one side of the paper and the detector on the other side of the paper. When the light is blocked and cannot reach the detector, the printer concludes that paper is present. When the light does reach the sensor, the printer concludes that there is no paper present.

The through-beam sensor can also be used in a manner similar to a Black Mark sensor. Instead of a Black Mark, a hole is used in the paper. The through-beam sensor is located on the centerline of the paper path. This is the only location it may use.

3.6.2. Paper Pre-End (Paper Low) Sensor Option

When ordered with the Paper Pre-End Sensor option, the eXtendo[®] will be shipped with a paper pre-end sensor to be mounted by the customer. The sensor is a reflex type, meaning that it senses paper by bouncing light off the paper and detecting its reflection. The sensor is equipped with a 300 mm long cable to allow flexible mounting by the customer, and the sensor itself is mounted on a small printed circuit board with a hole to be used for mounting it. Simply mount the sensor where it will detect paper low (it is often mounted facing the side of the paper roll, so that as the diameter of the paper roll decreases, it eventually loses the reflection of the light and changes state), and plug the PPE sensor into the upper sensor connector on the control board. While the exact distance of the sensor from the paper varies from application to application, it is typically 2-5 mm for optimal sensing.

If a paper roll holder and Paper Pre-End (Paper Low) Sensor were both ordered, the PPE sensor will be mounted to the paper roll holder, and the sensor connector need only be plugged into the eXtendo[®] controller board, (if necessary). Figure 5A below shows the PPE sensor itself, while Figure 6 is the input circuit to the Paper Pre-End (Paper Low) input.

The lower sensor connector is for an Auxiliary Sensor, which can be mounted as desired by the customer. The status of this sensor will be reported when the eXtendo[®] status is requested via the interface. The Auxiliary Sensor connector is located below the Paper Pre-End (Paper Low) Sensor connector.

Figure 6 shows the input circuit for these sensor connectors. (Fig. 6 represents the circuit for either the Paper Low or Auxiliary Sensor pair; these two inputs are wired identically.) Please note that each sensor input has two connectors, one on each side of the printer. The Paper Pre-End (Paper Low) Sensor connectors are designated CN6 and CN6', while the Auxiliary Sensor connectors are CN8 and CN8'. Only one connector of each pair (for example, CN6 and CN6') should be connected at one time.

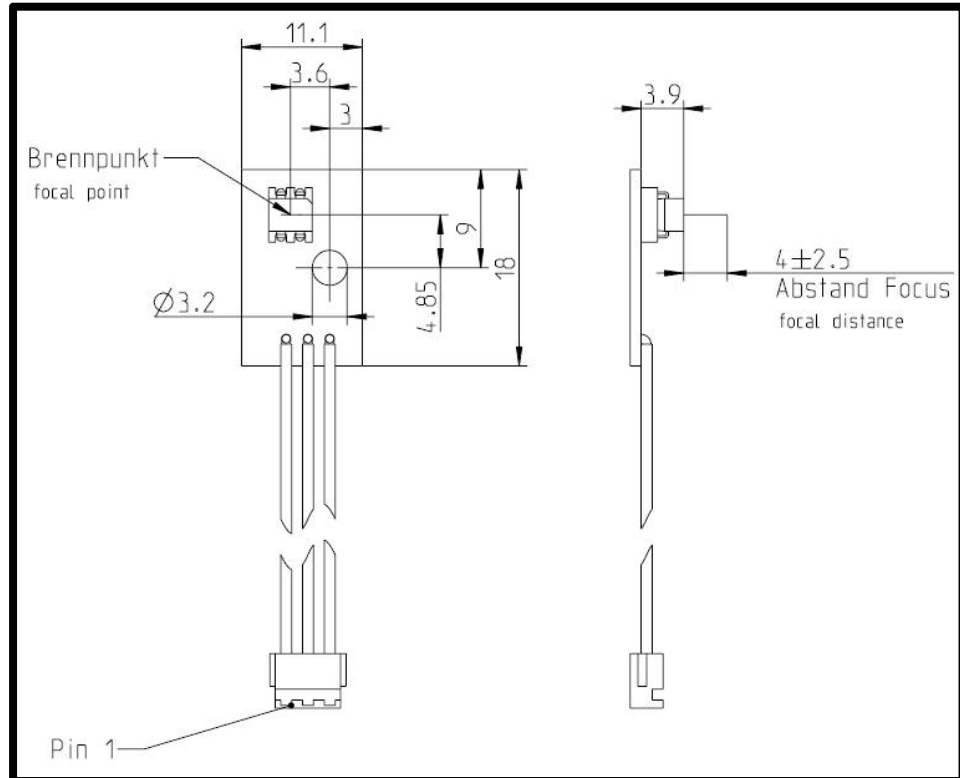

Fig. 5A

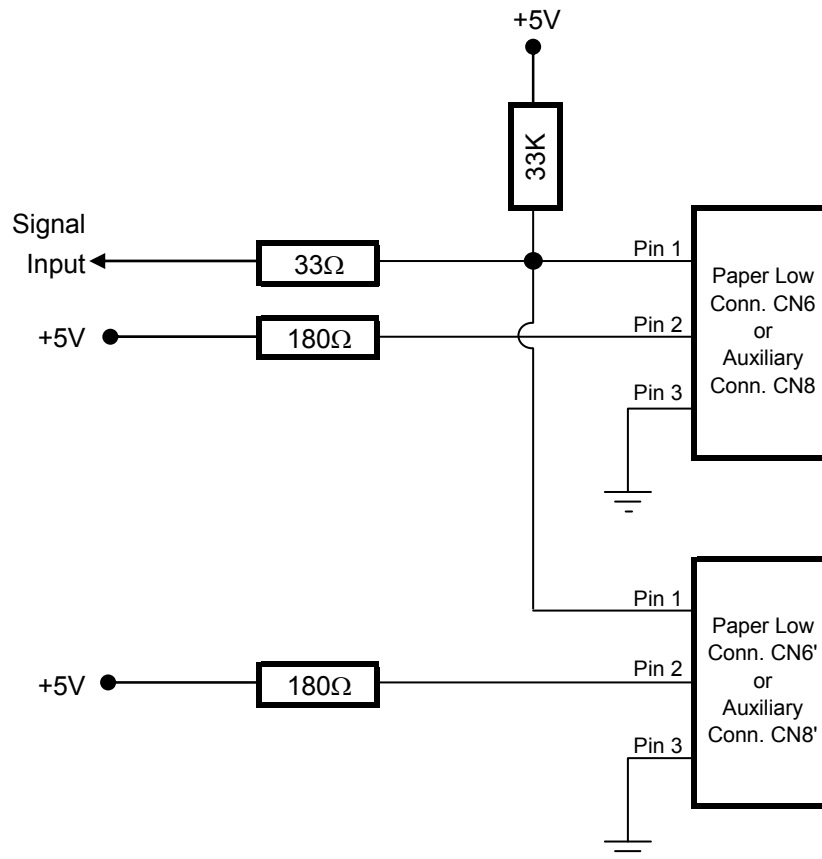

Figure 6

3.6.3. LED Indicators

There are two LED indicators in the eXtendo[®] series printers, located as shown in Fig. 2 and 3. The upper LED is red, and the lower one is green. (In some early samples, the upper LED is also green. If you have such a sample, any time you see reference to the “red” LED, you should consider that the “upper” LED.) These LEDs are used to signal some status information concerning the eXtendo[®] printer. The following is a partial listing of the information supplied.

There are several flashing speeds used in the eXtendo[®] printer LEDs. These are:

Slow: 0.5 Hertz (LED is “on” for one second and “off” for one second)

Medium: 5 Hz (“on” for 100 ms and “off” for 100 ms)

Fast (Flicker, or “F”): 10 Hz (“on” for 50 ms and “off” for 50 ms)

Green LED	Red LED	Meaning
Slow	Off	Normal operation.
Medium	Off	Out of paper.
Flicker	On	Data upload in progress (fonts, images, firmware, not normal data communication)
F0F	On	Printhead raised, printer stalled or over voltage. (Green LED will flicker, then go off for one second, then flicker and repeat.)
F1F	On	Paper error. (Green LED will flicker, then go off for one second, on for one second, off for one second, then flicker again and repeat.)
F2F	On	Cutter error. (Same pattern as above, but off, on, off, on, off.)
Off	On	Boot failure.
Flicker	Flicker	Initialization error.
On	On	System “hung” during initialization.

Please note that much more detailed information concerning the printer’s current state can be obtained by requesting the printer’s status via the interface. Please refer to the eXtendo[®] Emulation Command Set Reference D 684 112 for details.

3.6.4. Head Status Sensor

An additional Head Status Sensor is used to determine whether the printhead is in the up (do not print) or down (ready to print position). Normally, most of the heat generated by thermal printing is transferred to the paper being printed and is removed from the printer as the paper advances. When the printhead is up, no heat is being transferred to the paper and the heat remains in the individual dots, allowing them to overheat if activated repeatedly. Because this may cause permanent damage to the printer, the eXtendo[®] firmware will prevent printing or paper loading if the head is up.

The output of this sensor is also available from the Query function. See the eXtendo[®] Emulation Command Set Reference D 684 112 for details on determining the printhead position and the printhead temperature.

3.6.5. Chute/Jam Sensor (Optional)

The optional chute/jam sensor continually monitors whether there is paper in the chute, and can be read via the Status function. (Please see the eXtendo[®] Emulation Command Set Reference D 6840112 for details.) This function is often used in conjunction with the host’s peripherals to signal the user when a printout is not taken. Examples where this is important include when the information is confidential, or the printout can be redeemed for cash or items of value. This function can also be used to prevent the host from sending a new print job until the printout from the previous print job has been removed.

Additionally, the optional chute/jam sensor is monitored while first printing after a cut. After a cut, the printer “knows” where the end of the paper is. As printing takes place, the printer also “knows” how many paper advance steps have been made, and approximately when the end of the paper should reach the chute/jam sensor. If the paper does not reach the sensor when expected, the printer assumes that a paper jam has taken place and signals this fact via the Status command.



Note: Care must be taken when mounting the eXtendo printers to insure that the sensor is not exposed to direct sunlight. The multiple wavelengths of sunlight can cause false readings from this sensor. Therefore, always shield the chute and sensor from direct sunlight by the use of chutes, shrouds, covers and similar techniques.

3.7. Features Selected at Time of Order

One of the strengths of the eXtendo[®] family of thermal printers is that it allows the designer to select precisely the features needed, rather than settling for performance less than desired or having to pay for features that will never be used. The current set of available options is listed below.

Feature Description	Option 1	Option 2	Option 3
Basic Unit	X-56	X-80	
Communications Interface	USB	Serial (RS-232)	
Cutter	Twincut, Full and Partial Cut, up to 120 g/m ²	Twincut, Full Cut Only, up to 160 g/m ²	Rotary, Full Cut Only, up to 250 g/m ²
Print Speed	350 mm/sec max.		
Chute/Jam Sensor	Not included	Included	
Environmental Range	-25 to +70°C 20% to 100% RH	0 to +50°C 25% to 80% RH, non-condensing	
Software Configuration	Advanced		
Voltage	24 VDC	12 VDC	10-36 VDC
Sleep Mode	Not included	Included	
Presenter (available Q3 2008)	Not included	Included	
Paper Roll Holder	Not included	100 mm roll mounted on data connector side	100 mm roll mounted on gear side
		150 mm roll mounted on data connector side	150 mm roll mounted on gear side
		300 mm roll mounted on data connector side (avail. Q3/2009)	300 mm roll mounted on gear side (avail. Q3/2009)
Paper Chute	Not included	Included	
Paper Pre-End Sensor	Not included	Included	
Paper Guides Note: Standard on X-80	Not included	Included	
Extended Warranty	Not included	3 year warranty total	

Due to the wide variety of options possible, it is necessary to be able to identify what features are included in each printer. Some features, such as the cutter or PPE sensor, are visually obvious. Other features, such as the print speed, software configuration and extended warranty, are not. Therefore, this data is stored as a code in each printer when it is

print driver. This print driver, which is unique for each printer, translates what is on the screen as a graphic into graphic Native Commands to be sent to the printer. **Everything printed through a print driver prints as graphics.** It takes a lot more data to transmit graphics than to transmit ASCII. In our 40 character example, assuming a 12 x 20 pixel character, the Hengstler X-80 printer would require 1,600 bytes to print one line. (Please note that these are estimates, and that various compression routines also impact the print speed.)

The advantage of Graphic printing, then, is the ability to print anything; pictures, text, photos, etc. exactly as you see it on your screen. The disadvantage is that to do so, much more data (40 times as much data in our example) must be sent over the interface.

As a practical matter, then, it comes down to this. If you are doing ASCII printing, you can use USB or a serial interface. Both are fast enough to handle the smaller amount of data being sent. But if you are doing Graphic printing, USB is a far better choice due to its higher speed, and serial may increase the time to complete a printout to an unacceptably long period.

4. Unpacking

Care should be taken when unpacking your eXtendo[®] printer to preserve the packing material for possible future use. eXtendo[®] packing is specifically designed to protect the printer from damage in the harsh environment of trucks and aircraft. Please be sure to use this packing if it ever becomes necessary to reship your eXtendo[®] unit.

5. Major Options

5.1. Sleep Mode

eXtendo[®] printers can be supplied with an optional Sleep Mode feature, which will cause the printer to enter a very low current “standby” mode. This reduces current consumption when not printing. This feature is most often used when operating from batteries or when printing is done very infrequently.

There are two additional connectors available with the Sleep Mode Option. First, power is connected to the Sleep Mode board’s power connector rather than to the main control board power connector. This is to allow the Sleep Mode board to disconnect the power from the rest of the printer to greatly reduce the power consumption. The connector on the Sleep Mode board is the same one as is used for the main control board. Just plug the same connector as specified under the “Power” section above into the Sleep Mode Power Connector rather than into the main Power Connector.

The second connector is an RJ-45C connector. It can be used to both make a serial connection to the printer and to provide a hardware “wake up” line for the sleep mode. The RJ-45C pinout is as follows.

Sleep Mode RJ-45C Pinout

<i>Pin #</i>	<i>Signal name</i>	<i>I/O Function (printer view)</i>
1	RTS\	Ready to send
2	CTS\	Clear to send
3	DTR	Wake up printer
4	n/c	no connection
5	GND	I/O Signal Ground
6	n/c	no connection
7	RXD\	Receive data
8	TXD\	Transmit Data

Please note that it is possible to use only pins 3 and 5, waking up the printer using the RJ-45 while communicating via the primary interface. Once wired, the Sleep Mode option functions as shown below.

NOTE: Any time that power is initially applied through the Sleep Mode board, **the eXtendo[®] printer will power up already asleep**. Therefore, the first step that must be taken after power application to the printer is to wake the printer using the techniques in the “Wake Up” section below.

NOTE: When using the Sleep Mode option with a serial interface, serial handshaking cannot be used when communicating with the printer. This is because one of the handshake lines is used to wake the printer from Sleep Mode.

5.1.1. “Go To Sleep”

How the eXtendo[®] printer is put to sleep depends upon the setting of a soldered jumper on the Sleep Mode board.

If J1 is shorted (the default setting), the following hex command sequence sent over the USB or serial interface will put the printer to sleep: 0x1B 0xF2 0x02 0x05 0x00 0x00 0x00 0x00 0x00. This command is ignored if the printer is not equipped with the Sleep Mode Option.

If J1 is open, the printer will go to sleep when the DTR line goes high, regardless of the interface type being used.

5.1.2. “Wake Up”

Similarly, how the eXtendo[®] printer wakes up also depends upon a jumper.

If J2 is shorted (the default setting), sending the printer six null characters (0x00) over the serial interface will cause the printer to wake up.

If J2 is open, the printer will wake up on receipt of **any** six characters over the serial interface.

Regardless of the setting of J1 or J2, pulling DTR low will also cause the printer to wake up.

Please note that if your printer is equipped with a USB interface, you must either send the “Wake Up” command (either six nulls or six of any character, depending upon J2) over the serial interface, or use the DTR line to Awaken the printer.

There is a delay of approximately 3.5 seconds from the time that the “Wake Up” command/signal is sent until the printer is fully ready to print. This time is preprogrammed into the Sleep Mode option to give the eXtendo[®] printer itself adequate time to boot and to self-test.

Current consumption of the eXtendo[®] printer when equipped with Sleep Mode and “Asleep” is 50 μ A average.

6. Installation

6.1. Function



Please note that the eXtendo[®] printer is a module designed to be integrated into a system and to be operated only as a part of that system, for example, in a kiosk. All technical specifications and instructions contained in this manual and related documentation must be considered and complied with in order to achieve successful operation in the completed system.

6.2. Mounting Printer

The eXtendo[®] printer is built with four mounting holes for mounting from below, and four holes for mounting from the side. These holes are molded into bosses which are part of the plastic frame. Due to the very tough nature of the plastic used for the eXtendo[®], we recommend the following screws for mounting the printer.

Side Mounting Holes: EJOT Delta PT30, max. penetration into the printer 8 mm

Bottom Mounting Holes: EJOT Delta PT40, max. penetration into the printer 8 mm

These screws are available from Hengstler as a “mounting kit” to simplify your sourcing needs. Hole layouts (viewed from above the printer) for mounting the X-56 and X-80 models with screws from underneath are shown below. Please refer to the drawings specified in section 1.1 for more detailed dimensions and mounting hole locations for mounting from the side.

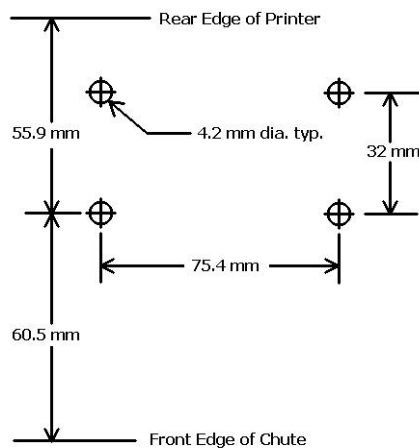

Figure 7a – X-56

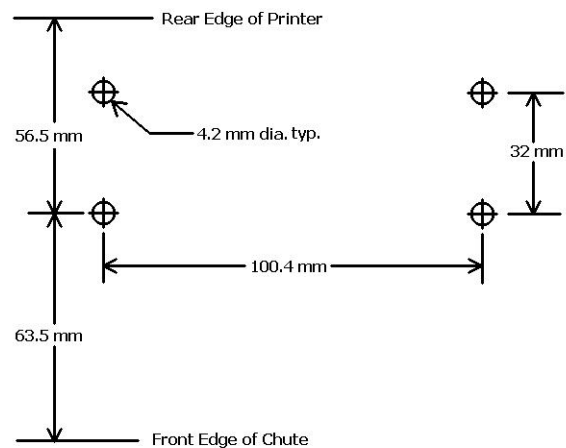

Figure 7b – X-80



Note: The eXtendo[®] printer is designed with a cutter cover that is hinged and can be tilted down to gain access to the cutter. However, the printer is designed such that this cover can be tilted down only if the printer is mounted at the edge of a shelf. (See Fig. 8.) Attempting to lower this cover if the printer is back from the edge on a flat surface will likely damage the cutter cover! Please be aware of this when selecting your printer mounting location.

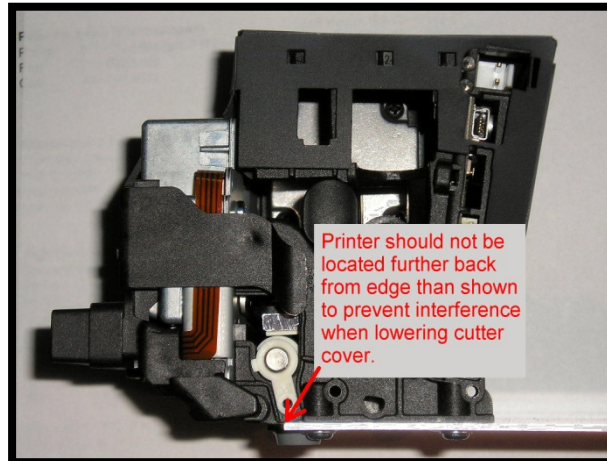

Figure 8

6.3. Installing Paper Guides

Depending upon the model and the options ordered, the eXtendo[®] family of thermal printers may come with a pair of paper guides. Since the paper guides are only used for certain width papers, and should not be used with other widths, they are not installed at the factory. Paper guides should be utilized as follows.

No. of Guides	Paper Width	Paper Width
	X-56	X-80
none	58-60 mm	84-86 mm
one	55-57 mm	81-83 mm
two	49-54 mm	60-80 mm

Use the following procedure to install paper guides. Please note that the cover has been removed from the printer to make it easier to see the paper guide area.

1. Locate the paper guides in a small bag packed with the printer and remove them. Note that the slotted, funnel-shaped opening is oriented towards the printer, and that the extended arms of the paper guide (see figure 9) should point towards the middle of the printer.



Figure 9

2. Note that the paper guide has four tabs that are intended to engage the printer. Two tabs are at the end of the arms, and two tabs are near the slotted "funnel". Locate the slotted area at the back of the printer. (See figure 10.) Position the tabs on the funnel end in the middle of the slotted area of the side in which you will mount them, making sure to be clear of the gear teeth molded into the printer, then press down until these two tabs snap into place.

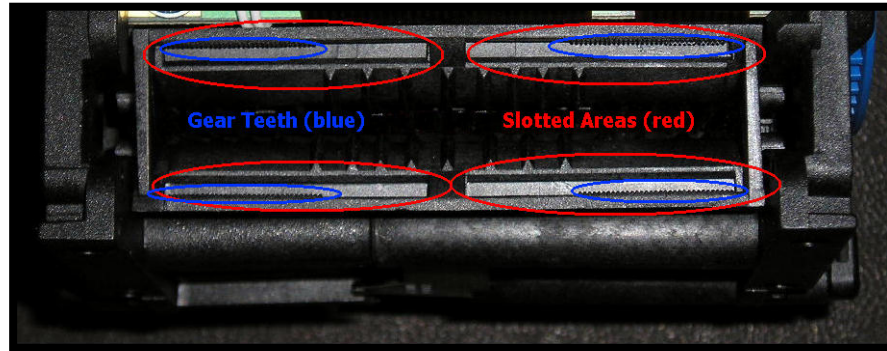

Figure 10

3. Slide the paper guide all the way to the outer edge of the slotted area. Press on first one, then the other of the arms to snap these two tabs into place.
4. The paper guide is now installed. Push or pull on the end of the paper guide to position it where desired. (See figure 11.) You will hear the paper guide click as it locks into each position.

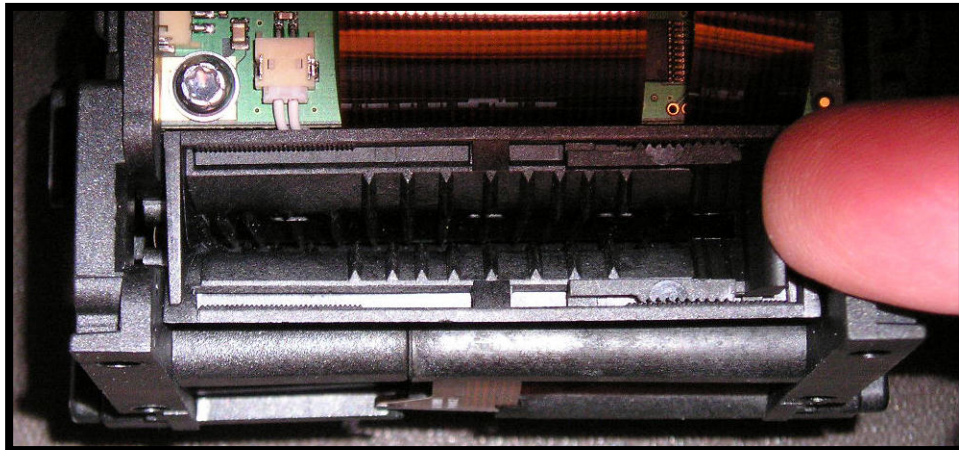

Figure 11

6.4. Wiring

6.4.1. Power

Power is connected to the eXtendo[®] thermal printer via a JST connector. The connector consists of a JST VHR-2N (RA 3.96) shell and two SVH-21T-P1.1 contacts. Wiring is as follows:

<i>Pin</i>	<i>Function</i>
1	24 VDC (-)
2	24 VDC (+)

The upper contact on the connector is common; the lower contact is the positive (+) voltage. See the "Sleep Mode" section for connection of power when equipped with the Sleep Mode option.



6.4.2. Interfacing

Serial

The printer is shipped with the following serial settings as default: 115,200 baud, 8 data bits, one stop bit, no parity, hardware flow control, and host transmission not blocked. (This last feature is intended for use with lower sophistication hosts that cannot read the eXtendo® printer's status data. It uses the hardware handshake lines to prevent the host from sending more data if the printer registers "paper out".)

The serial versions of the eXtendo® printer use a JST ZHR-6 connector shell with JST SZH-002T-P0.5 contacts to make the RS-232 connection. Hengstler can provide a serial cable for direct connection to PCs with a DB-9 connector on one end. Connections are as follows, should you wish to make your own connectors.

Serial Pinout

<i>DB-9 female Pin #</i>	<i>ZHR-6 Pin#</i>	<i>I/O Function (Printer view)</i>
8	1	RTS\
7	2	CTS\
5	3	GND
2	4	TXD\
3	5	RXD\
--	6	n/c (leave unconnected)
1		n/c
4 		jumper to pin 6
6 		jumper to pin 4
9		n/c
Shell		Earth Ground



Please note that the Hengstler cable is supplied with a flying pigtail on the printer end. This pigtail is intended to be fastened under the grounding screw, as shown in Fig. 2 and 3, to provide maximum reduction of radiated electrical noise.



For additional protection against accidental cable removal, the cable tie-downs (see Fig. 2 and 3) are provided as a point to which you may fasten cables using cable ties (not provided).

USB

The USB versions of the eXtendo® printer employ a standard digital camera USB interface cable (5 pin Mini-B connector on the printer end) to communicate from the host to the printer. Be sure that the Mini-B connector is fully engaged with the mating connector on the printer. The other end of the cable plugs into the USB port on the host.

Once the printer is connected with the host and the driver is installed, be sure to set the Port in the driver to the appropriate USB port to match the physical host-side interface cable port.

USB Pinout

<i>Pin Number</i>	<i>Signal name</i>	<i>I/O Function</i>
1	NC	no connection
2	D- I/O	Data -
3	D+ I/O	Data +
4	NC	no connection
5	SGND	I/O Signal Gnd



Please note that the shell of the USB connector automatically makes the ground connection that is made via the pigtail in the serial version.

6.5. Paper Supply

6.5.1. Hengstler Paper Roll Holders

Hengstler offers two paper roll holders for use with the eXtendo[®] family of thermal printers. One is a small holder intended to position 100 mm rolls of thermal paper in various positions behind or below the printer. The second paper roll holder is intended for paper rolls up to 150 mm diameter, and otherwise has similar characteristics to the 100 mm version. Both paper roll holders will accept paper pre-end sensors.

6.5.2. Designing Your Own Paper Roll Holder

It is sometimes desirable for customers to design their own paper roll holder in order to fit in the available space, or to tailor performance to their specific needs. Based on our extensive experience in designing printers, we would urge you to consider the following topics and implement your design with care.

Large Diameter Rolls: When using paper rolls over 100 mm in diameter, a “dancer bar” should be considered. This usually takes the form of a spring-loaded arm under which the paper is placed before feeding it into the printer. As the printer starts to print, slack is taken up from the paper roll. This starts to lift the arm against the spring, which puts force on the paper roll and starts it moving slowly. As more printing takes place the roll gradually accelerates until it’s up to printing speed. Without the dancer bar, slack paper would be taken up until it was suddenly no longer slack. Now the printer must accelerate a large, heavy paper roll from zero speed to full print speed in essentially no time. This usually causes the paper advance motor to stall or the paper to slip against the platen, causing shortened characters until the paper roll is up to speed.

Spindle Friction: Another important consideration is spindle friction. As a paper roll rotates, it slides against the spindle that holds it, assuming a fixed spindle. This friction will tend to impede the paper roll’s free motion, and is dependent upon the weight of the roll, the smoothness and material of the spindle, and the smoothness and material of the paper core. When possible, especially with paper rolls over 100 mm in diameter, design the spindle so that it can rotate, greatly decreasing friction and drag.

Catch Points: More paper jams and transport problems are caused by catch points than any other issue. Make sure that the paper path is free of anything that can interfere with free paper flow, especially any sharp edges or “pinch points” into which the paper may stray and become caught.

Alignment: Any paper roll holder design must hold the paper square to the printer in all planes. If the paper is angled in any way, it will enter the printer at an angle and will be more likely to cause paper jams.

Rigidity: It is important that the paper roll holder support the paper firmly and not move. This is especially true in high-speed printing applications and in large diameter paper roll applications. Many paper roll holders are made from metal too thin to support the heavy paper rolls they are expected to handle. This results in twisting and warpage while printing, which binds the paper and causes paper jams. Vibration during printing may also cause undesired movement of the paper roll.

Shipment: Do not ship your product with a paper roll mounted in the paper roll holder. The heavy weight of the paper roll can easily bend or otherwise damage the paper roll holder, as witnessed numerous times.

6.6. Power Supply Specifications

Selection of a power supply for thermal printers depends upon the printer's application, what percentage of the printout is black, frequency with which printouts are generated, and more. In particular, thermal printers draw very high currents for very short time periods (usually under one millisecond). The most important issue is not peak current, but the length of time that the power supply is able to deliver instantaneous current over its rated maximum, and for how long the print job prints high black percentages, thereby drawing high current. It is important that the power supply's over-current system does not shut down the power supply when these brief, high current surges occur.

With that said, we recommend the following power supply specifications for most 24 VDC applications. Please see the "Technical Specifications" section near the end of this document for full details on the various voltages available.

DC Output Voltage: 24 volts \pm 5%

DC Output Current (nominal): 4 amperes

Hold Up Time: 20 ms minimum

Current Limitations: 16 amperes minimum current limit

7. Operation

7.1. Loading Paper

The eXtendo[®] series of thermal printers automatically loads paper when it is inserted. First, make sure that the printhead is in the "down" position by pulling the Printhead Position Control to the outer position. Then insert the paper, thermosensitive side up, into the paper slot in the rear. You will hear the paper feed motor start to run as soon as the paper detection sensor is reached. Continue to feed the paper until the platen grasps it and pulls it into the printer.

The eXtendo[®] thermal printer family is designed to use paper with the thermosensitive side on the **outside** of the paper roll. This is important as the printer is optimized to deal with paper curl angling the paper end downward.

Please note that the eXtendo[®] thermal printer family will, unless specifically configured not to do so, print an Information Report immediately when paper is loaded. This short report is extremely helpful during setup and configuration of the eXtendo[®] printer. This report contains detailed information, some of it encoded, concerning the printer itself and its features, the firmware installed, the status of information in the flash memory, and the 20+ settings that configure the printer itself.

One example of how this report can be used involves the serial version of the eXtendo[®] printer family. If you want to verify the current serial settings (baud rate, stop bits, parity, etc.), simply remove and reinsert the paper. This information is printed as part of the Printer Information report. Please note that many of the software tools supplied with the eXtendo[®] driver also allow this report to be printed without removing the paper. Simply click on the "Print Info" button.

7.2. Printhead Position Control

The printhead position control (see Figures 2 and 3) is used to raise and lower the thermal printhead. This control moves in and out of the side of the printer, and has two positions.

The “out” position lowers the printhead to the platen so that the printer is ready to print. The “in” position raises the printhead off the platen. The printer is shipped with the printhead in the “in” raised position; it must be lowered to the “out” “ready to print position” for use.

Leaving the printhead in contact with the platen for a long period of time without paper under the printhead may cause a temporary indentation in the platen, which can result in initial feeding difficulties. If this occurs, simply push the Printhead Position Control in to raise the printhead, insert paper, and then pull the Printhead Position Control out while the motor is running.

7.3. Paper Advance Wheel

The eXtendo[®] family of printers is equipped with a Paper Advance Wheel to make it simple to manually advance paper when needed. (See Fig. 5.) Rotating this wheel counterclockwise (the direction labeled “Paper In” on the wheel) will draw paper in from the paper supply at the rear of the printer. Rotating the wheel clockwise (the direction labeled “Paper Out” on the wheel) will cause paper to back out of the rear of the printer.

7.4. Print Speed

Print speed is affected by many factors. First, the maximum print speed is dependent upon the operating version of the eXtendo[®] version that you ordered. Even with the maximum print speed in the firmware set to 350 mm/sec, the 12 volt and 10-36 volt models will not exceed 130 mm/sec. Other significant factors affecting print speed include:

- Type of interface / ASCII printing vs. Graphics printing
- Data transmission rate (serial)
- Density settings
- Dot history factor
- Burn time correction setting
- Multi-strobe factor
- Limited print speed specified at time of ordering

7.5. Cutter Operation

The cutters used in the eXtendo[®] series printer are either Twincut guillotine types or rotary cutter types, depending upon what is ordered. All types are motor driven and use internal cam action to provide feedback as to when the cutter has returned to its home position. Twincut versions with full and partial-cut capability can make full or partial cuts under software control. Technical specification sheets on standard versions of the cutters themselves are available upon request from Hengstler.

Please note that, when dealing with an eXtendo[®] with the Twincut guillotine cutter, the cutter blades can be manually moved without removing the cutter cover. Simply insert a small, flat bladed screwdriver in the screw slot located in the area circled in Fig. 12, and turn. This will manually turn the motor, moving the blades. This is useful in clearing paper jams.



Please be sure to remove power from the printer before moving the cutter blades, and keep your fingers clear of the blades themselves.

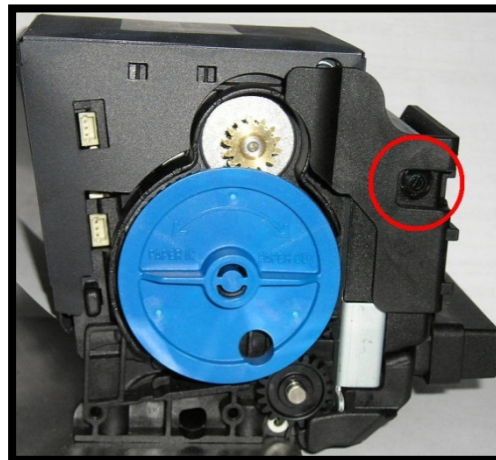

Figure 12

7.5.1. Partial Cut with Chute Sensor

The behavior of the eXtendo® family of printers when using the full- and partial-cut guillotine version of the cutter is different when a partial-cut is made and the printer is equipped with a chute sensor. With the sensor, the platen motor is locked after the partial cut is made to make it easy to tear the remaining paper tab and to prevent vandals from pulling the paper off the paper roll inside the printer. After approximately 30 seconds, if the sensor detects that the paper has not yet been taken, the printer will do a full cut to foil any vandals.

When the printer is not equipped with the chute sensor, it cannot detect if the partially-cut printout has been taken. The printer then locks the platen motor after a partial cut for 30 seconds. However, at the end of that time, the motor will unlock. It is then possible for vandals, if they are careful and pull gently, to pull paper from the paper roll. Therefore, we strongly recommend that all customers order the chute/jam sensor option if they will make partial cuts. Since the same cutter can be used for full-cut and partial-cut applications, it is not possible to tie the requirement for the chute sensor to the type of cutter ordered.

7.6. eXtendo® Digital Tools

The eXtendo® family of thermal printers includes with the Windows XP driver a series of very useful tools. These can be run directly from the Tools folder of the driver package once the driver has been installed. A brief summary of these tools is as follows.

eXtendo® Command Tool: Very simple tool for sending Native Commands to the printer.

eXtendo® Configuration Tool: A very important tool that allows you to change virtually any variable setting or performance characteristic of your eXtendo® printer.

eXtendo® Diagnostic Tool: A useful tool for identifying possible issues with your printer, its peripherals and firmware.

eXtendo® Font Tool: Used for uploading and assigning different fonts within the eXtendo® printer.

eXtendo® Image Tool: This very helpful tool creates eXtendo® format graphic files from standard format graphic files so they can be uploaded as stored images.

eXtendo[®] Print Terminal: Possibly the most useful tool of the bunch, the Print Terminal has six sets of 24 buttons each, most of them preprogrammed to transmit commands to your eXtendo[®] printer. All buttons are programmable to make them transmit whatever is needed. This tool is very popular with software developers who are integrating the eXtendo[®] into their products.

eXtendo[®] Uninstaller Tool: Use this tool to uninstall single or all versions of the eXtendo[®] driver.

eXtendo[®] Upload Tool: Used to upload new firmware, specific data files, etc. to the flash area of your eXtendo[®] printer.

eXtendo[®] Wide Font Tool: Used for creating Wide Font formats (such as Chinese or Korean) from standard graphic files.

8. Low Current Operation

There are numerous factors that affect thermal printer current. It is possible to manipulate these factors consciously to reduce current draw for situations where this is important, such as operating from batteries. If battery operation only occurs when power has failed, the host software can be programmed to print at a faster, higher current rate during normal operation and then switch the eXtendo[®] to a lower current mode when the system switches to battery operation. The following are some considerations to aid in reducing current draw.

8.1. *Print Speed*

With thermal printers, average current is proportional to print speed. Since the burn time for each dot row is fixed, when printing slower there is more pause between burns and therefore a lower average current. (The peak current is determined by the number of dots burned at once, and so is unaffected by print speed.) The eXtendo[®] target print speed (called the “target speed” because other settings may cause the actual print speed to be lower than this) can be set via the interface; please refer to the eXtendo[®] Emulation Command Set Reference for the specific command sequence. The slower this print speed is, the lower the average current draw will be. Note that when using the eXtendo[®] Windows XP driver, the driver will override settings sent to the printer directly via the interface.

8.2. *Graphics/Bar Codes*

Printing graphics rather than text consumes more current than printing only text. Typical text-only printing is considered to be 12.5% coverage on average, while graphic printing varies from 25% to 50% average, consuming 2X to 4X the average current. Printing bar codes is in the same category, and draws about 4X the current of text. Both should be avoided or minimized to reduce current draw. In terms of current draw, it does not matter whether printing is done using the printer’s internal character set or the via the driver.

8.3. *Reverse Printing*

Reverse printing should be avoided, since everything that’s normally black becomes white, and vice-versa, drawing (in average text) about 8 times the current.

8.4. *Dot History Factor*

Dot history monitors previously burned dots and reheats them for a shorter time to prevent blooming and excessively black areas, thereby decreasing total current consumption. Using dot history and minimizing the main burn time will reduce average current draw. Please refer to the eXtendo[®] Emulation Command Set Reference for the specific command sequence.

8.5. *Burn Time Correction*

The eXtendo[®] family of printers include a feature that will adjust burn time automatically depending upon ambient temperature. Burn Time Correction allows the adjustment of these

burn times to “tune” the printer to maximum performance for any given paper, thereby improving print quality but having little effect on current consumption. If current draw is truly critical, reducing these values will reduce current slightly at the cost of lower contrast in the printout. Please refer to the eXtendo[®] Emulation Command Set Reference for the specific command sequence.

8.6. Multi-Strobe Factor

This feature is the only eXtendo[®] software feature that will reduce **peak** current. When this feature is turned on, only one side of the printhead is fired at a time, reducing the peak current by a factor of two, but having virtually no effect on average current. This is very useful if your power supply has a restrictive maximum current, but slows printing. Please refer to the eXtendo[®] Emulation Command Set Reference for the specific command sequence.

8.7. Print Density Adjustment

Increasing print density will improve print quality, but at the same time will increase average current. Therefore Print Density is always a trade-off between these two characteristics. Use the lowest print density that is visually acceptable to minimize current draw. Please refer to the eXtendo[®] Emulation Command Set Reference for the specific command sequence.

8.8. Sleep Mode

eXtendo[®] printers can be ordered with a Sleep Mode option, which allows the printer to be put into an extremely low current mode where it draws microamps instead of milliamps in the idle state. This option requires a “wake up” command in order to return it to the “ready” state before printing, but represents significant current savings if battery operation is continuous and printing is infrequent. Please refer to the eXtendo[®] Emulation Command Set Reference and the eXtendo[®] Operating Manual for detailed information.

9. Troubleshooting

Symptom	Possible Cause	Corrective Action
No LEDs light on printer	<ol style="list-style-type: none"> 1. Power not connected 2. PCB mounted fuse blown 	<ol style="list-style-type: none"> 1. Check line cord and outlet 2. Return printer for fuse replacement; not field replaceable
LEDs flashing	See Section “LED Indicators”	See Section “LED Indicators”
Printer will not feed paper	<ol style="list-style-type: none"> 1. Print head raised (LEDs will flash; see Section “LED Indicators”) 	<ol style="list-style-type: none"> 1. Lower print head
Printer will not load paper and makes loud noise	<ol style="list-style-type: none"> 1. Printer left with no paper under printhead 	<ol style="list-style-type: none"> 1. Raise printhead, insert paper, lower printhead
Printer prints blank paper	<ol style="list-style-type: none"> 1. Paper inserted upside-down 2. Wrong side of roll coated 	<ol style="list-style-type: none"> 1. Invert paper roll 2. Invert roll as test, have paper made properly
Print quality poor	<ol style="list-style-type: none"> 1. Print density set too low 2. Printhead not fully lowered 	<ol style="list-style-type: none"> 1. Adjust print density, other burn time adjustments. 2. Lower printhead.
Baud rate, other configuration setting changes not implemented after use of Configuration Tool	<ol style="list-style-type: none"> 1. Printer was not reset after changes made with Configuration Tool. 	<ol style="list-style-type: none"> 1. Reset printer.

10. Maintenance

The eXtendo[®] printers are intended to be maintenance-free, and as such do not require any regular service or maintenance.

11. Repair

All Hengstler printers are repaired at our facility in Aldingen, Germany. For details, and to arrange for the return of a printer for repair, please contact us at:

HENGSTLER GmbH
Uhlandstrasse 49
78554 Aldingen / Germany
Tel. +49 (0) 7424-89 0
Fax +49 (0) 7424-89 500
eMail: info@hengstler.com
www.hengstler.com

12. Buying Paper

12.1. Sourcing Paper

In order to maintain your warranty, use only paper that conforms with eXtendo[®] Paper Specification D 684 122. Use of paper that does not conform with this specification may adversely affect the performance of your eXtendo[®] printer and/or damage your printer. Please note that the eXtendo[®] can use either roll or fanfold paper. When using fanfold paper, care must be taken to configure the printer, black mark, and positioning so that the cut always occurs **after** the fanfold bend, not on it or before it. Failure to do so will cause cutting problems and will likely increase paper jams.

12.2. Converting Paper

Thermal paper is usually purchased through paper converters. These companies buy large, jumbo rolls of specific paper types from the few true paper manufacturers in the world and then cut it and roll it to your specifications. You may elect to have preprinting or black marks added at this time, as well. Please make sure that any paper a converter wishes to supply you for use with your eXtendo[®] printer conforms with eXtendo[®] Paper Specification D 684 122.

12.3. Black Mark Sensor Location

The Black Mark sensors on the eXtendo® printers can be located in numerous positions during manufacturing, both above and below the paper (sensing the printed side and the paper back, respectively). Figure 13 represents X-56 and X-80 paper, and show where the black marks should be located in order to be detected with the sensor located on the printable (coated) side of the paper. Areas shown in dotted lines are on the back side of the paper with the sensor below the paper. The numbers shown inside each black mark area are the Black Mark Position numbers. Only positions 1/2 for X-56 and 3/8 for X-80 (both of each pair is used) can be employed for a through-beam sensor. The default sensor positions are so marked. Please note that sensor locations other than the default location are intended for OEM applications.

In order to avoid accidental interpretation of preprinted information as the black mark, it's necessary to keep the area 5 mm to the left and right of the black mark edges for the entire length of the printout free of all printing except Pantone Safety Colors with a print contrast (PCS) value of under 15%, as measured by MacBeth RD924. The black mark itself must have a print contrast over 80%, per DIN 66223, measured with MacBeth PCM2, Filter B. This applied to the side of the printout where the black mark is located, regardless of whether it is the thermal-coated side or not. The blue area shown in Fig. 13 shows this zone for the default sensor position 6 of the X-56.

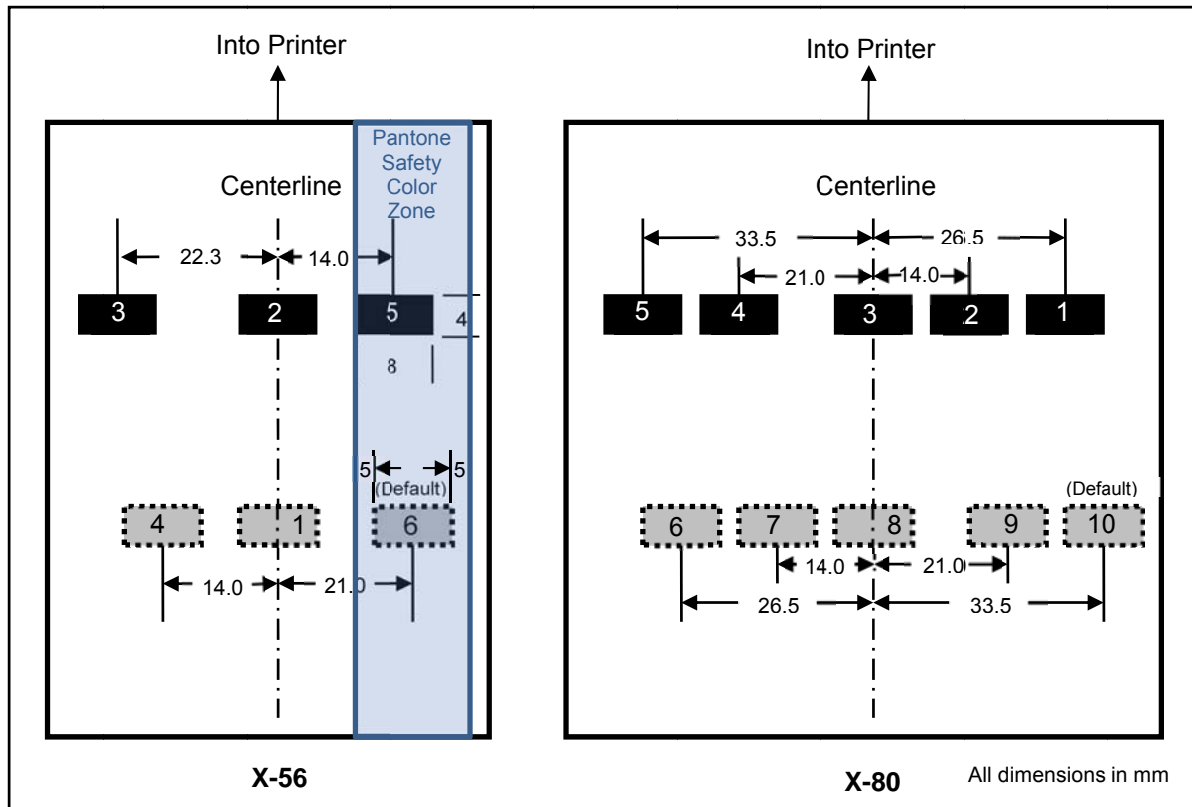

Figure 13

13. Technical Specifications

13.1. General Specifications (X-56 and X-80)

Technology:	Direct Thermal
Resolution:	203 dpi (8 dots/mm)
Paper Weight:	50 to 250 g/m ² (cutter/model dependent, higher in some cases)
Cutter:	Guillotine (full or partial cut) or Rotary Type (heavy stock)
Interface Types:	a) USB 1.1 industrial Interface cable length 3 meters max. Transmission rate: 1.5 Mbit/sec and 12 Mbit/sec b) RS-232 Interface cable length 3 meters max. 4,800 to 115,200 baud
Bar Codes:	
<i>Internally Generated:</i>	UPC-A, UPC-E, EAN-13, EAN-8, Code 39, Interleaved 2 of 5, Code 128, Codabar, PDF 417, QR, Datamatrix
<i>Externally Generated:</i>	Any, generated by Windows [®] standard GDI file by host
Minimum Print Length:	15 mm. Note: At a length of 15 mm, the paper will not be visible at the end of the paper chute. Print at least 40 mm in order for the paper to be visible. The 15 mm minimum length is included to allow for applications where the printer is ordered without the chute and where very short printouts may be dropped into a chute or similar conveyance.
Temperature Range	
<i>Operating:</i>	-25°C to +70°C 20% to 100% RH (extended range) or 0°C to +50°C 25% to 80% RH, non-condensing
<i>Storage:</i>	-30°C to +75°C
Printhead Life	
<i>Abrasion:</i>	100 km of paper (<i>based on 12.5% print density</i>)
<i>Electrical:</i>	100 million dot pulses
Paper Roll Capacity:	150 mm (6 inch) roll diameter 300 mm (12 inch) (reduced performance)
Graphic Driver:	Windows [®] XP/7/8/10, Linux (CUPS)
Firmware:	Field uploadable

13.2. X-56 Specifications

Print Speed: 24 VDC: 350 mm/sec (13.7 ips) max.
 12 VDC: 130 mm/sec (5.1 ips) max.
 10-36 VDC: 130 mm/sec (5.1 ips) max.

Paper Width: 49-60 mm (1.93 to 2.36 inches)

Printable Width: 56 mm (2.20 inches)

Operating Voltage: 24 VDC ±5%
 12 VDC (11-15 VDC) (optional)
 10-36 VDC (optional)

Duty Cycle: 24 VDC: Thirty (30) 150 mm long printouts per minute max.
 12 VDC: Fifteen (15) 150 mm long printouts per minute max.
 10-36 VDC: For each printout up to 210 mm long and with a print density of 25% or less, a 9 second pause after each printout. Consult factory regarding duty cycle for print densities over 25%.

Current Draw:
 In standby, approx.
 Sleep mode (optional)
 While printing

90 mA
 <50 µA
 @21°C, print speed 100mm/s; current in **Amps avg.**

	Print density (pixel coverage)		
	12.5%	25%	50%
24 VDC	1.0	1.6	2.8
12 VDC	0.9	1.5	2.6
10-36VDC	0.9	1.5	2.6

Presenter (optional): Loop-type w/ retract
Dimensions (WxHxD): 100 x 92 x 120 mm (approx.)

13.3. X-80 Specifications

Print Speed: 24 VDC: 350 mm/sec (13.7 ips) max.

Paper Width: 60-86 mm (2.36 to 3.38 inches)

Printable Width: 80 mm (3.15 inches)

Operating Voltage: 24 VDC ± 5%

Duty Cycle: 24 VDC: Thirty (30) 150 mm long printouts per minute max.

Current Draw:
 In standby, approx.
 While printing

90 mA
 @21°C, print speed 100mm/s; current in **Amps avg.**

	Print density (pixel coverage)		
	12.5%	25%	50%
24VDC	1.4	2.3	4.0

Dimensions (WxHxD): 130 x 92 x 120 mm (approx.)

13.4. Electromagnetic Compatibility

13.4.1. FCC Part 15 Class B Device

NOTE: This equipment has been tested and found to comply with the limits for a Class B digital device, pursuant to Part 15 of the FCC Rules. These limits are designed to provide reasonable protection against harmful interference in a residential installation. This equipment generates, uses and can radiate radio frequency energy and, if not installed and used in accordance with the instructions, may cause harmful interference to radio communications. However, there is no guarantee that interference will not occur in a particular installation. If this equipment does cause harmful interference to radio or television reception, which can be determined by turning the equipment off and on, the user is encouraged to try to correct the interference by one or more of the following measures:

- Reorient or relocate the receiving antenna.
- Increase the separation between the equipment and receiver.
- Connect the equipment into an outlet on a circuit different from that to which the receiver is connected.
- Consult the dealer or an experienced radio/TV technician for help.

13.4.2. EN55022 – Emissions

The eXtendo[®] family of thermal printers are class “B” appliances, and comply to applicable Class “B” standards, when installed in a properly grounded housing with appropriate conductive shielding.



When operating the printer from a DC building power supply, or when the DC power cable exceeds 3 meters in length, appropriate EMI filters must be used.

13.4.3. EN55024 – Electromagnetic Susceptibility



Electrostatic discharges and burst effects may cause short printing interruptions, but the automatic recovery function of the printer will restore it to its original state.



Additional action regarding lightning and overvoltage protection will be needed if cables and wires are installed outside of a building.

However, this standard can be met only if original units, components, and cables are used and the installation instructions are respected and followed completely.



External interference caused by ESD or EMI can temporarily cause corrupted printing or data loss.

13.5. Printer Drawings

Please refer to the appropriate drawing listed in section 1.1 of this document for dimensions and complete mounting hole position information.